

- **MANUALE DI ISTRUZIONE PER SALDATRICE**

---

- **INSTRUCTION MANUAL FOR WELDING MACHINE**

---

- **BETRIEBSANLEITUNG FÜR SCHWEIßGERÄTE**

# **MAX 453/603**



**Info : [www.stelgroup.it](http://www.stelgroup.it) - tel. +39 0444 639525**

**DECLARATION OF CONFORMITY**

According to

The Low Voltage Directive 2014/35/EU

The EMC Directive 2014/30/EU

The RoHS Directive 2015/863/EU

The Ecodesign Directive 2009/125/EC

**Type of equipment**

MMA Welding Equipment

**Type of designation**

601506000L – MAX 453

601475000L – MAX 603

**Brand name or trade mark**

STEL

**Manufacturer or his authorized representatives established within the EEA:****Name, address, phone, website:**

STEL s.r.l

Via Del Progresso 59; 36020 Castegnero – Vicenza

Italy

Tel +39-0444-639525 Fax +39-0444-639682 www.stelgroup.it

**The following harmonized standard in force within the EEA has been used in the design:**

EN IEC 60974-1:2022 Ed. 6, Arc welding equipment – Part 1: Welding power sources

EN IEC 60974-10:2021 Ed.4, Arc welding equipment – Part 10: Electromagnetic compatibility (EMC)

**Additional information:** Restrictive use, Class A equipment, intended for use in locations other than residential.

By signing this document, the undersigned declares as manufacturer, or the manufacturer's authorized representative established within EEA, that the equipment in question complies with the safety requirements stated above.

**Date**

18-03-2025

**Signature**

Andrea Barocco

**Position**

General Manager

STEL s.r.l.  
Via Del Progresso, 59 - 36020 CASTEGNERO (VI)  
Tel. 0444/639525 - 639682 - Fax 0444/639641  
Cod. Fisc. e Part. IVA 02503180248  
C.N.A.A. 235766 - Iscritt. VI 36922

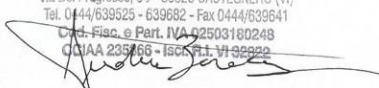

## SICUREZZE

### LO SHOCK ELETTRICO PUÒ UCCIDERE

- Disconnettere la macchina dalla rete di alimentazione prima di intervenire sul generatore.
- Non lavorare con i rivestimenti dei cavi deteriorati.
- Non toccare le parti elettriche scoperte.
- Assicurarsi che tutti i pannelli di copertura del generatore di corrente siano ben fissati al loro posto quando la macchina è collegata alla rete di alimentazione.
- Isolate Voi stessi dal banco di lavoro e dal pavimento (Ground): usate scarpe e guanti isolanti.
- Tenete guanti, scarpe, vestiti, area di lavoro, e questa apparecchiatura puliti ed asciutti.

### I CONTENITORI SOTTO PRESSIONE POSSONO ESPLODERE SE SALDATI.

Quando si lavora con un generatore di corrente:

- non saldare contenitori sotto pressione.
- non saldare in ambienti contenenti polveri o vapori esplosivi.

### LE RADIAZIONI GENERATE DALL'ARCO DI SALDATURA POSSONO DANNEGGIARE GLI OCCHI E PROVOCARE BRUCIATURE ALLA PELLE.

- Proteggere gli occhi ed il corpo adeguatamente.
- È indispensabile per i portatori di lenti a contatto proteggersi con apposite lenti e maschere.

### PREVENZIONE USTIONI

Per proteggere gli occhi e la pelle dalle bruciature e dai raggi ultravioletti:

- portare occhiali scuri. Indossare vestiti, guanti e scarpe adeguate.
- usare maschere con i lati chiusi, aventi lenti e vetri di protezione a norme (grado di protezione DIN 10).
- avvisare le persone circostanti di non guardare direttamente l'arco.

### IL RUMORE PUÒ DANNEGGIARE L'UDITO.

- Proteggersi adeguatamente per evitare danni.

### I FUMI ED I GAS POSSONO DANNEGGIARE LA VOSTRA SALUTE.

- Tenere il capo fuori dalla portata dei fumi.
- Provvedere per una ventilazione adeguata dell'area di lavoro.
- Se la ventilazione non è sufficiente, usare un aspiratore che aspiri dal basso.

### IL CALORE, GLI SCHIZZI DEL METALLO FUSO E LE SCINTILLE POSSONO PROVOCARE INCENDI.

- Non saldare vicino a materiali infiammabili.
- Evitare di portare con sé qualsiasi tipo di combustibile come accendini o fiammiferi.
- L'arco di saldatura può provocare bruciature. Tenere la punta dell'elettrodo lontano dal proprio corpo e da quello degli altri.

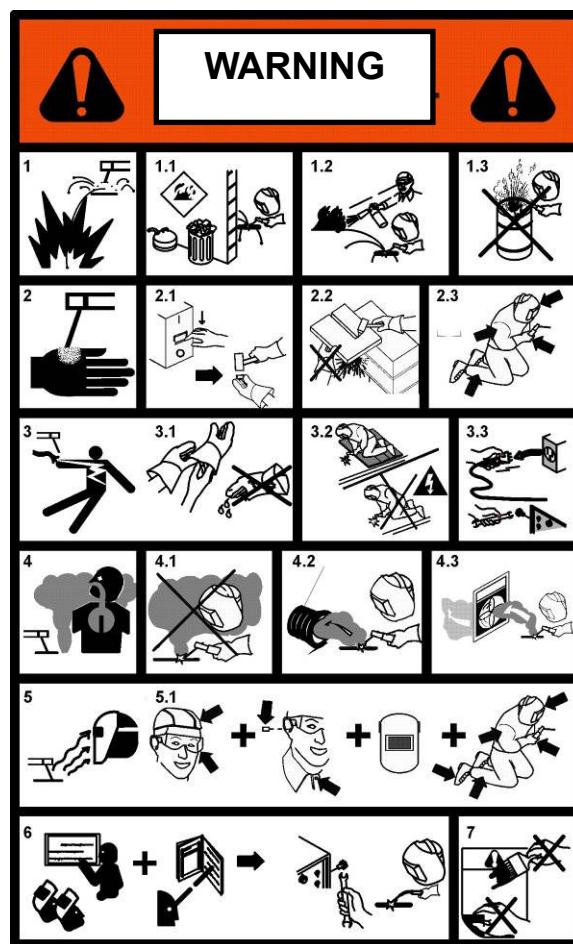

### PREVENZIONE INCENDI

La saldatura produce schizzi di metallo fuso.

Prendere le seguenti precauzioni per evitare incendi:

- assicurarsi un estintore nell'area di saldatura.
- allontanare il materiale infiammabile dalla zona immediatamente vicina all'area di saldatura.
- raffreddare il materiale saldato o lasciarlo raffreddare prima di toccarlo o di metterlo a contatto con materiale combustibile
- non usare mai la macchina per saldare contenitori di materiale potenzialmente infiammabile. Questi contenitori devono essere puliti completamente prima di procedere alla saldatura.
- ventilare l'area potenzialmente infiammabile prima di usare la macchina.
- non usare la macchina in atmosfere che contengano concentrazioni elevate di polveri, gas infiammabili o vapori combustibili.

### PREVENZIONE CONTRO SHOCK ELETTRICI

Prendere le seguenti precauzioni quando si opera con un generatore di corrente:

- tenere puliti sé stessi ed i propri vestiti.
- non essere a contatto con parti umide e bagnate quando si opera con il generatore.
- mantenere un isolamento adeguato contro gli shock elettrici. Se l'operatore deve lavorare in ambiente umido, dovrà usare estrema cautela, vestire scarpe e guanti isolanti.

- controllare spesso il cavo di alimentazione della macchina: dovrà essere privo di danni all'isolante. I CAVI SCOPERTI SONO PERICOLOSI

Non usare la macchina con un cavo di alimentazione danneggiato; è necessario sostituirlo immediatamente.

- se c'è la necessità di aprire la macchina, prima staccare l'alimentazione. Aspettare 5 minuti per permettere ai condensatori di scaricarsi. Non rispettare questa procedura può esporre l'operatore a pericolosi rischi di shock elettrico.

- non operare mai con il generatore, se la copertura di protezione non è al suo posto.

- assicurarsi che la connessione di terra del cavo di alimentazione, sia perfettamente efficiente.

Questo generatore è stato progettato per essere utilizzato in ambiente professionale ed industriale. Per altri tipi di applicazione contattare il costruttore. Nel caso in cui **disturbi elettromagnetici** siano individuati è responsabilità dell'utilizzatore della macchina risolvere la situazione con l'assistenza tecnica del costruttore. È vietato l'utilizzo e l'avvicinamento alla macchina da parte di persone portatori di stimolatori elettrici (PACE MAKERS).

## DESCRIZIONE GENERALE

Questa nuova serie di generatori a regolazione elettronica governata da microprocessore, consente di raggiungere una eccellente qualità di saldatura, grazie alle avanzate tecnologie applicate. Il circuito microprocessore controlla ed ottimizza il trasferimento dell'arco indipendentemente dalla variazione del carico e dell'impedenza dei cavi di saldatura.

I comandi sul pannello frontale consentono una facile programmazione delle sequenze di saldatura in funzione delle esigenze operative.

La tecnologia inverter usata ha permesso di ottenere:

- generatori con peso e dimensioni estremamente contenuti;
- ridotto consumo energetico;
- eccellente risposta dinamica;
- fattore di potenza e rendimenti molto alti;
- caratteristiche di saldatura migliori;
- visualizzazione su display dei dati e delle funzioni impostate.

I componenti elettronici sono racchiusi in una robusta carpenteria facilmente trasportabile e raffreddati ad aria forzata con ventilatori a basso livello di rumorosità.

N.B. Il generatore non è adatto per sgelare tubi.

## RICEVIMENTO

L'imballo contiene:

- N. 1 generatore
- N. 1 manuale sicurezze

Verificare che siano compresi nell'imballo tutti i materiali sopra elencati. Avvisare il Vs. distributore se manca qualcosa. Verificare che il generatore non sia stato danneggiato durante il trasporto. Se vi è un danno evidente, vedere la sezione RECLAMI per istruzioni. Prima di operare con il generatore leggere attentamente questo manuale di istruzioni.





## RECLAMI





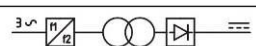

**Reclami per danneggiamento durante il trasporto:**

Se la Vs. apparecchiatura viene danneggiata durante la spedizione, dovete inoltrare un reclamo al Vs. spedizioniere.

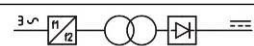
**Reclami per merce difettosa:** Tutte le apparecchiature spedite da STEL sono state sottoposte ad un rigoroso controllo di qualità. Tuttavia se la Vs. apparecchiatura non dovesse funzionare correttamente, rivolgetevi al Vs. concessionario autorizzato.

## DATI TECNICI

		Via Del Progresso, 59 36020 Castegnero (VI) - ITALY			
		TYPE: MAX 453 p/n 601506000L		EN 60974-1 EN 60974-10	
					
A		4 A / 20,16 V		450 A / 38 V	
		U <sub>0</sub> V	I <sub>2</sub>	450 A	430 A
B		4 A / 10,16 V		450 A / 28 V	
		U <sub>0</sub> V	I <sub>2</sub>	450 A	430 A
C		15 A / 14,75 V		450 A / 36,5 V	
		U <sub>0</sub> V	I <sub>2</sub>	450 A	430 A
D		U <sub>1</sub>	V   I <sub>MAX</sub>	A   I <sub>EFF</sub>	A
		400	33,5	24,5	
IP 23				Made in Italy	

A	 Via Del Progresso, 59 36020 Castegnero (VI) – ITALY																								
	<b>TYPE: MAX 603 p/n 601475000L</b>	<b>EN 60974-1</b> <b>EN 60974-10</b>																							
B																									
		<table border="1"> <tr> <td colspan="2">4 A / 20,16 V</td> <td colspan="3">550 A / 42 V</td> </tr> <tr> <td>U<sub>0</sub></td> <td>V</td> <td>I<sub>2</sub></td> <td>35%</td> <td>60%</td> <td>100%</td> </tr> <tr> <td>70</td> <td></td> <td>U<sub>2</sub></td> <td>550 A</td> <td>500 A</td> <td>400 A</td> </tr> <tr> <td></td> <td></td> <td></td> <td>42 V</td> <td>40 V</td> <td>36 V</td> </tr> </table>	4 A / 20,16 V		550 A / 42 V			U <sub>0</sub>	V	I <sub>2</sub>	35%	60%	100%	70		U <sub>2</sub>	550 A	500 A	400 A				42 V	40 V	36 V
	4 A / 20,16 V		550 A / 42 V																						
	U <sub>0</sub>	V	I <sub>2</sub>	35%	60%	100%																			
70		U <sub>2</sub>	550 A	500 A	400 A																				
			42 V	40 V	36 V																				
	<table border="1"> <tr> <td colspan="2">4 A / 10,16 V</td> <td colspan="3">550 A / 32 V</td> </tr> <tr> <td>U<sub>0</sub></td> <td>V</td> <td>I<sub>2</sub></td> <td>35%</td> <td>60%</td> <td>100%</td> </tr> <tr> <td>70</td> <td></td> <td>U<sub>2</sub></td> <td>550A</td> <td>500A</td> <td>400A</td> </tr> <tr> <td></td> <td></td> <td></td> <td>32 V</td> <td>30 V</td> <td>26 V</td> </tr> </table>	4 A / 10,16 V		550 A / 32 V			U <sub>0</sub>	V	I <sub>2</sub>	35%	60%	100%	70		U <sub>2</sub>	550A	500A	400A				32 V	30 V	26 V	
4 A / 10,16 V		550 A / 32 V																							
U <sub>0</sub>	V	I <sub>2</sub>	35%	60%	100%																				
70		U <sub>2</sub>	550A	500A	400A																				
			32 V	30 V	26 V																				
	<table border="1"> <tr> <td colspan="2">15 A / 14,75 V</td> <td colspan="3">550 A / 41,5 V</td> </tr> <tr> <td>U<sub>0</sub></td> <td>V</td> <td>I<sub>2</sub></td> <td>35%</td> <td>60%</td> <td>100%</td> </tr> <tr> <td>70</td> <td></td> <td>U<sub>2</sub></td> <td>550A</td> <td>500A</td> <td>400A</td> </tr> <tr> <td></td> <td></td> <td></td> <td>41,5 V</td> <td>39 V</td> <td>35 V</td> </tr> </table>	15 A / 14,75 V		550 A / 41,5 V			U <sub>0</sub>	V	I <sub>2</sub>	35%	60%	100%	70		U <sub>2</sub>	550A	500A	400A				41,5 V	39 V	35 V	
15 A / 14,75 V		550 A / 41,5 V																							
U <sub>0</sub>	V	I <sub>2</sub>	35%	60%	100%																				
70		U <sub>2</sub>	550A	500A	400A																				
			41,5 V	39 V	35 V																				
C		<table border="1"> <tr> <td>U<sub>1</sub></td> <td>V</td> <td>I<sub>MAX</sub></td> <td>A</td> <td>I<sub>EFF</sub></td> <td>A</td> </tr> <tr> <td>400</td> <td></td> <td>50</td> <td></td> <td>30</td> <td></td> </tr> </table>	U <sub>1</sub>	V	I <sub>MAX</sub>	A	I <sub>EFF</sub>	A	400		50		30												
	U <sub>1</sub>	V	I <sub>MAX</sub>	A	I <sub>EFF</sub>	A																			
400		50		30																					
D		<table border="1"> <tr> <td>IP 23</td> <td></td> <td></td> <td>Made in Italy</td> </tr> </table>	IP 23			Made in Italy																			
IP 23			Made in Italy																						

#### A) IDENTIFICAZIONE

Nome, indirizzo del costruttore

Tipo generatore

Identificazione riferita al numero di serie

Simbolo del tipo di generatore

Riferimento alla normativa di costruzione

#### B) DATI DISALDATURA

Simbolo del processo di lavoro

Simbolo per generatori idonei ad operare in ambiente a rischio accresciuto di scossa elettrica.

Simbolo della corrente

Tensione assegnata a vuoto (tensione media)

Gamma della corrente

Valori del ciclo di intermittenza (su 10 minuti)

Valori della corrente assegnata

Valori della tensione convenzionale a carico

#### C) ALIMENTAZIONE

Simbolo per l'alimentazione (numero fasi e frequenza)

Tensione assegnata di alimentazione

Massima corrente di alimentazione

Massima corrente efficace di alimentazione (identifica il fusibile di linea)

#### D) ALTRE CARATTERISTICHE

Grado di protezione.

MAX 453/603		
Efficienza al 100% ED	MMA	87%
Potenza a vuoto	MMA	65 W

## INSTALLAZIONE

### ATTENZIONE:

Questa apparecchiatura in **CLASSE A** non è destinata all'uso in ambienti residenziali dove la potenza elettrica è fornita dal sistema pubblico di alimentazione a bassa tensione. Ci possono essere potenziali difficoltà a garantire la compatibilità elettromagnetica di questi ambienti a causa di disturbi condotti e irradiati.

Il generatore MAX 453/603 non rispetta i limiti della **IEC 61000-3-12**.

Se collegato alla rete BT industriale pubblica è responsabilità dell'installatore o dell'utilizzatore assicurarsi, previa consultazione dell'Ente distributore, se lo stesso è collegabile.

Il buon funzionamento del generatore è assicurato da un'adeguata installazione; è necessario quindi:

- Sistemare la macchina in modo che non sia compromessa la circolazione d'aria assicurata dal ventilatore interno.
- Evitare che i ventilatori immettano nella macchina depositi o polveri.
- E' bene evitare urti, sfregamenti, ed in maniera assoluta l'esposizione a stiliyadi, fonti di calore eccessive, o comunque situazioni anomale.

### TENSIONE DI RETE

Il generatore funziona con queste tensioni di alimentazione:

MAX 453/603                      400V±15% 3F

e Fuse rating di

MAX 453                            25A 3F

MAX 603                            32A 3F

### COLLEGAMENTO

- Prima di effettuare connessioni elettriche tra il generatore di corrente e l'interruttore di linea, accertarsi che quest'ultimo sia aperto.

- Il quadro di distribuzione deve essere conforme alle normative vigenti nel paese di utilizzo.

-L' impianto di rete deve essere di tipo industriale.

-Predisporre una apposita presa che preveda l'alloggiamento dei conduttori del cavo di alimentazione.

-Per i cavi più lunghi maggiorare opportunamente la sezione del conduttore.

-A monte, l'apposita presa di rete dovrà avere un adeguato interruttore munito di fusibili ritardati.

## CONNESSIONE TRIFASE

Per collegare il generatore ad una presa trifase standard seguire lo schema seguente:

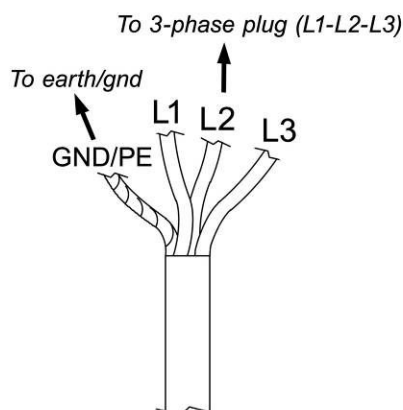

## MESSA A TERRA

- Per la protezione degli utenti il generatore dovrà essere assolutamente collegato correttamente all'impianto di terra (NORMATIVE INTERNAZIONALI DI SICUREZZA).

- E' indispensabile predisporre una buona messa a terra tramite il conduttore giallo-verde del cavo di alimentazione, onde evitare scariche dovute a contatti accidentali con oggetti messi a terra.

Lo chassis (che è conduttivo) è connesso elettricamente con il conduttore di terra; non collegare correttamente a terra l'apparecchiatura può provocare shock elettrici pericolosi per l'utente, e un non corretto funzionamento del generatore.

## SOLLEVAMENTO

### ATTENZIONE

Il generatore pesa:  
MAX 453/603

50 Kg / 110 lb



### Sollevamento manuale

Per sollevare manualmente il generatore servirsi delle due apposite maniglie.



### Sollevamento tramite gancio e cinghia

Per il sollevamento con gancio e cinghia usare esclusivamente i le maniglie come indicato nel disegno.

Durante il sollevamento tenere il generatore in posizione orizzontale.



## AVVERTENZA POSIZIONAMENTO PRECARIO

Se il generatore cade può causare infortuni.  
Non mettere in funzione o spostare il generatore nel caso si trovi in posizione precaria.  
Non posizionare il generatore su piani inclinati superiori a 10°.

## DESCRIZIONE PANNELLO FRONTALE

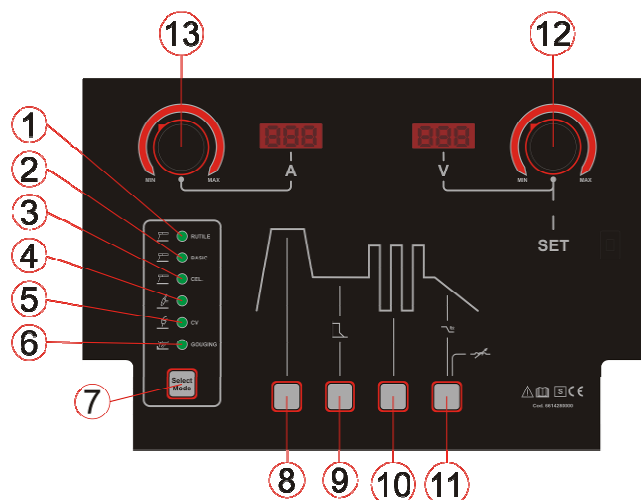

- 1 Led modalità saldatura ELETTRODO RUTILE;
- 2 Led modalità saldatura ELETTRODO BASICO;
- 3 Led modalità saldatura ELETTRODO CELLULOSICO;
- 4 Led modalità saldatura TIG LIFT;
- 5 Led modalità MIG CV;
- 6 Led modalità SCRICCATURA;
- 7 Pulsante **SELECT MODE**;
- 8 Pulsante impostazione **Hot start**;
- 9 Pulsante impostazione **Arc force**;
- 10 Pulsante impostazione **modalità pulsata DC**;
- 11 Pulsante impostazione **rampa di discesa/induttanza di uscita**;
- 12 Encoder regolazione tensione / funzioni **V/SET** ;
- 13 Encoder regolazione corrente **A**;

## DISPOSIZIONE SALDATURA AD ELETTRODO

- 1) Rispettare le indicazioni fornite precedentemente a riguardo dell'allacciamento primario e dell'installazione;
- 2) Collegare il cavo di massa alla presa dinse. Polarità negativa (-);
- 3) Collegare la pinza porta elettrodo alla presa della macchina polarità positiva (+);
- 4) Inserire l'anima scoperta dell'elettrodo nella pinza porta elettrodi;
- 5) Premere il pulsante **Select Mode** (rif.7) fino a selezionare una delle modalità ELETTRODO, indicata dall'accensione del rispettivo **LED** (rif.1,2,3,6);
- 6) Impostare la corrente di saldatura con l'encoder di regolazione **A** (rif.13);
- 7) Procedere con la saldatura.

### V.R.D. (SOLO IN MODALITA' ELETTRODO/TIG/GOUGING)

La sigla V.R.D. sta per VOLTAGE REDUCTION DEVICE che non è altro che un sistema per la riduzione della tensione a vuoto. Quando si installa il V.R.D. in una saldatrice esso riduce la tensione a vuoto massima ad una tensione di sicurezza che normalmente è al di sotto dei 18V.

- Il V.R.D. è usato come aiuto ulteriore per la sicurezza dell'operatore.
- Le procedure per la sicurezza sul lavoro devono sempre essere seguite con attenzione.

### ATTIVAZIONE DEL V.R.D.

- 1) Accendere il generatore,
- 2) Tener premuto il pulsante **Select Mode** (rif.7) per circa 4 secondi, rilasciare poi il pulsante; il led modalità elettrodo corrispondente lampeggia, (FUNZIONE V.R.D. INSERITA Vout 18V). La modalità VRD rimane inserita anche dopo lo spegnimento e la riaccensione della macchina

### ESCLUSIONE DEL V.R.D.

- 1) Accendere il generatore,
- 2) Tener premuto il pulsante **Select Mode** (rif.7) per circa 4 secondi, rilasciare poi il pulsante; il led modalità elettrodo rimane fisso, (FUNZIONE V.R.D. esclusa). La modalità VRD rimane sempre esclusa anche dopo lo spegnimento e la riaccensione della macchina.

## DISPOSIZIONE SALDATURA TIG

- 1) Rispettare le indicazioni fornite precedentemente a riguardo dell'allacciamento primario e dell'installazione;
- 2) Collegare il cavo di massa alla presa dinse. Polarità positiva (+);
- 3) Collegare la torcia alla presa della macchina polarità negativa (-);
- 4) Collegare l'attacco del gas per la torcia all'apposito raccordo sul pannello anteriore della macchina;
- 5) Allacciare la bombola del gas all'apposito raccordo posto sul pannello posteriore della macchina;
- 6) Premere il pulsante **Select Mode** (rif.7) fino a selezionare la modalità TIG, indicata dall'accensione del rispettivo **LED** (rif.4);
- 7) Impostare la corrente di saldatura con l'encoder di regolazione **A** (rif.13);
- 8) Procedere con la saldatura.

## DISPOSIZIONE SALDATURA MIG



In questa modalità il generatore si comporta da generatore a tensione costante, per saldare in modalità MIG è necessario collegarlo tramite fascio cavi ad un alimentatore di filo compatibile. In caso di collegamento con un alimentatore di filo è l'alimentatore a prendere controllo dei parametri di saldatura.

Alimentatori di filo compatibili:

- TOP 504 XXM
- TOP 504 SMX
- TOP 504 NAVY 5/15 ALU \* (kit adattatore cod.601632000L)
- SKY YARD 5/15 \* (kit adattatore cod.601631000L)

## PROTEZIONE PER SOVRACORRENTE

Se la corrente di saldatura dovesse superare i 580 Ampere interviene una protezione che abbassa automaticamente la corrente di saldatura. Segnalazione su alimentatore di filo.

## DISPOSIZIONE PER SCRICCATURA

Per le applicazioni di scriccatura vengono impiegati generalmente generatori per saldatura a tre fasi con una tensione del circuito aperto superiore a 60 volt per consentire ogni tipo di caduta di tensione nel circuito.

1. Collegare il cavo elettrico di saldatura che è collegato al cavo orientabile della torcia al terminale positivo sul generatore. Consultare la figura.
2. Collegare il cavo elettrico di saldatura che è collegato al terminale negativo sul generatore al pezzo in lavorazione.

Accendere il generatore e l'alimentazione dell'aria verso la torcia di scriccatura e il fascio di cavi.

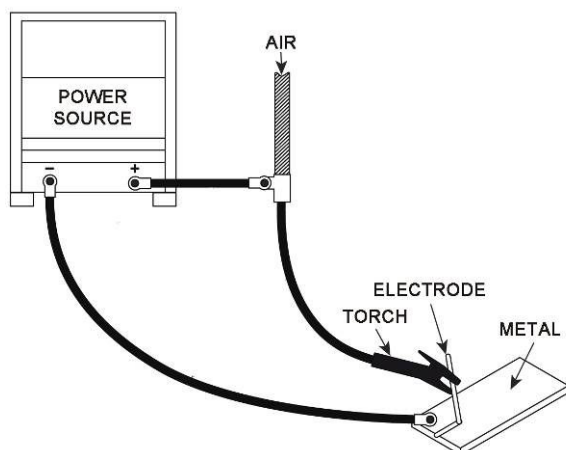

4. Quando la valvola della torcia è aperta, regolare la pressione dell'aria della torcia entro l'intervallo di pressioni normali tra 552 kPa (80 psi - 5,5bar) e 690 kPa (100 psi - 6,9bar); pressioni più elevate possono essere utilizzate, ma non rimuovono il materiale in modo efficace.

5. Abbassare la leva della torcia per inserire il "carbone" dell'elettrodo dell'arco con elettrodo di carbone e aria compressa nella torcia. Quando si utilizzano carboni rivestiti con rame, l'estremità scoperta del carbone deve trovarsi in basso e lontano dalla torcia. Questo è il punto in cui verrà scoccato l'arco tra il carbone e il pezzo in lavorazione. Consultare la figura.

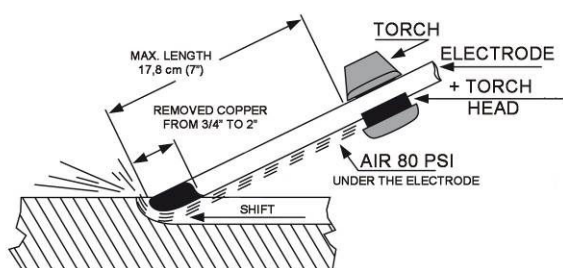

6. Tenere l'elettrodo come mostrato nella figura, facendo in modo che dalla torcia fuoriescano massimo 178 mm (7"). La prolunga dovrebbe essere di 76,5 mm (3") per l'alluminio.

7. Regolare la corrente di saldatura, secondo la gamma di corrente indicata per il diametro di carbone utilizzato (vedi pag.28 -Gouging electrodes-).

## IMPOSTAZIONI

### REGOLAZIONE HOT START(ELETTRODO)

Premendo il pulsante **Hot start** (rif. 8) appare nel display il valore di Hot start impostato, è possibile regolarlo con l'encoder **V/SET** (rif. 12).

H.S.= 0-30% RUTILE  
= 0-50% BASIC  
= 0-50% CEL.

### REGOLAZIONE ARC FORCE (ELETTRODO)

Premendo il pulsante **Arc Force** (rif. 9) appare nel display il valore di Arc Force impostato, è possibile regolarlo con l'encoder **V/SET** (rif. 12).

A.F.= 0-30% RUTILE  
= 0-50% BASIC  
= 100-350% CEL.

### REGOLAZIONE PULSAZIONE DC (TIG/ELET.)

Tenendo premuto il pulsante **modalità pulsata** (rif. 10) per 3 secondi si attiva la pulsazione DC segnalata con il lampeggio dei due puntini del display di sinistra. Premendo consecutivamente il tasto (rif. 10) è possibile regolare la frequenza di pulsazione (PFR) il duty cycle (PdU) e la corrente di base (Ilo) tramite l'encoder **V/SET** (rif. 12), Per disattivare la modalità pulsazione occorre tenere premuto 3 secondi il tasto (rif. 10).

PFR= 0,4 – 5 Hz MMA / 0,4 – 999 Hz TIG  
PdU= 10-90%  
Ilo= 10-90%

### REGOLAZIONE INDUTTANZA ELETTRONICA (MIG CV)

Premendo il pulsante **induttanza elettronica Car** (rif. 11) appare nel display il valore di Induttanza impostato (25-200), è possibile regolarlo con l'encoder **V/SET** (rif. 12).

### REGOLAZIONE RAMPA DI DISCESA (TIG)

Premendo il pulsante **rampa di discesa SLd** (rif. 11) appare nel display il valore di rampa di discesa impostato (0,1-10sec), è possibile regolarlo con l'encoder **V/SET** (rif. 12).



## SEGNALAZIONI DISPLAY

### ERRORE COMUNICAZIONI CON ACCESSORI:



Questo messaggio indica un problema di comunicazione con gli accessori.

Controllare la connessione del connettore 14poli tra generatore e accessori.

Spegnere e riaccendere il generatore.

### SOVRATEMPERAURA:



Questo messaggio indica una sovra temperatura, il numero indica la posizione del sensore che ha rilevato la sovra temperatura:

-HT 1, HT 2, HT 3, HT 4 = sonda NTC modulo igt 1,2,3,4.

-HTd 5, HTd 7 = sonda NTC diodi secondari.

-HTd 005, HTd 007 = termostato XL out 1 e 2.

### MANCANZA FASE



Questo messaggio indica la mancanza di una fase della tensione di alimentazione. Verificare la presenza corretta delle tre fasi all'ingresso del generatore.

## SMALTIMENTO APPARECCHIATURE ELETTRICHE ED ELETTRONICHE



Non smaltire le apparecchiature elettriche assieme ai rifiuti normali! In ottemperanza alla Direttiva Europea 2012/19/UE sui rifiuti da apparecchiature elettriche ed elettroniche e relativa attuazione nell'ambito della legislazione nazionale, le apparecchiature elettriche giunte a fine vita devono essere raccolte separatamente e conferite ad un impianto di riciclo ecocompatibile. In qualità di proprietario delle apparecchiature dovrà informarsi presso il nostro rappresentante in loco sui sistemi di raccolta approvati. Dando applicazione a questa Direttiva Europea migliorerà la situazione ambientale e la salute umana!

IN CAO DI CATTIVO FUNZIONAMENTO RICHIEDETE L'ASSISTENZA DI PERSONALE QUALIFICATO.

## DUTY CYCLE E SOVRATEMPERATURA

Il ciclo di intermittenza è la percentuale di utilizzo della saldatrice su 10 minuti che l'operatore deve rispettare per evitare che scatti il blocco di erogazione per sovratemperatura.

### 100% ED (ciclo intermittenza)



### 60% ED (ciclo intermittenza)



Se la macchina entra in sovratemperatura apparirà il messaggio HT (vedi segnalazioni display sovratemperatura).

Dopo 4 minuti di blocco ( necessari per il raffreddamento ) il messaggio scomparirà e il generatore è nuovamente abilitato alla saldatura.

## SAFETY

### ELECTRIC SHOCK CAN KILL

- Disconnect the power supply before working on the welding machine.
- Do not work with deteriorated cable sheaths.
- Do not touch bare electrical parts.
- Ensure that all the panels covering the welding machine are firmly secured in place when the machine is connected to the mains supply.
- Insulate yourself from the work bench and from the floor (ground): use insulating footwear and gloves.
- Keep gloves, footwear, clothes, the work area and this equipment clean and dry.

### PRESSURISED CONTAINERS CAN EXPLODE IF WELDED.

When working with a welding machine:

- do not weld pressurised containers.
- do not weld in environments containing explosive powders or vapours.

### THE RADIATIONS GENERATED BY THE WELDING ARC CAN DAMAGE THE EYES AND CAUSE BURNING OF THE SKIN.

- Provide suitable protection for the eyes and body.
- **It is indispensable for contact lens wearers to protect themselves with suitable lenses and masks.**

### NOISE CAN DAMAGE YOUR HEARING.

- Protect yourself suitably to avoid hearing damage.

### FUMES AND GASES CAN DAMAGE YOUR HEALTH.

- Keep your head out of the reach of fumes.
- Provide suitable ventilation of the work area.
- If the ventilation is not sufficient, use an exhaust system that sucks from the bottom.

### HEAT, SPLASHES OF MOLTEN METAL AND SPARKS CAN CAUSE FIRES.

- Do not weld near inflammable materials.
- Avoid having any type of fuel with you such as cigarette lighters or matches.
- The welding arc can cause burns. Keep the tip of the electrode far from your body and from other persons.

### PREVENTION OF ELECTRIC SHOCKS

Take the following precautions when working with a welding machine:

- keep yourself and your clothes clean.
- do not be in contact with damp or wet parts when working with the welding machine.
- maintain suitable insulation against electric shock. If the operator has to work in a damp environment, he must take extreme care and wear insulating footwear and gloves.
- check the machine power cable frequently: it

must be free from damage to the insulation. **BARE CABLES ARE DANGEROUS.** Do not use the machine if the power cable is damaged; it must be replaced immediately.

- if it is necessary to open the machine, first disconnect the power supply. Wait 5 minutes to allow the capacitors to discharge. Failure to take this precaution may expose the operator to dangerous risks of electric shock.
- never work with the welding machine if the protective cover is not in place.
- ensure that the earth connection of the power supply cable is perfectly efficient.

This machine has been designed for use in a professional and industrial environment. For other types of application contact the manufacturer. If **electromagnetic disturbances** are found it is the responsibility of the machine user to solve the problem with the technical assistance of the manufacturer.

**It is forbidden for people with PACEMAKERS to use or come near the machine.**

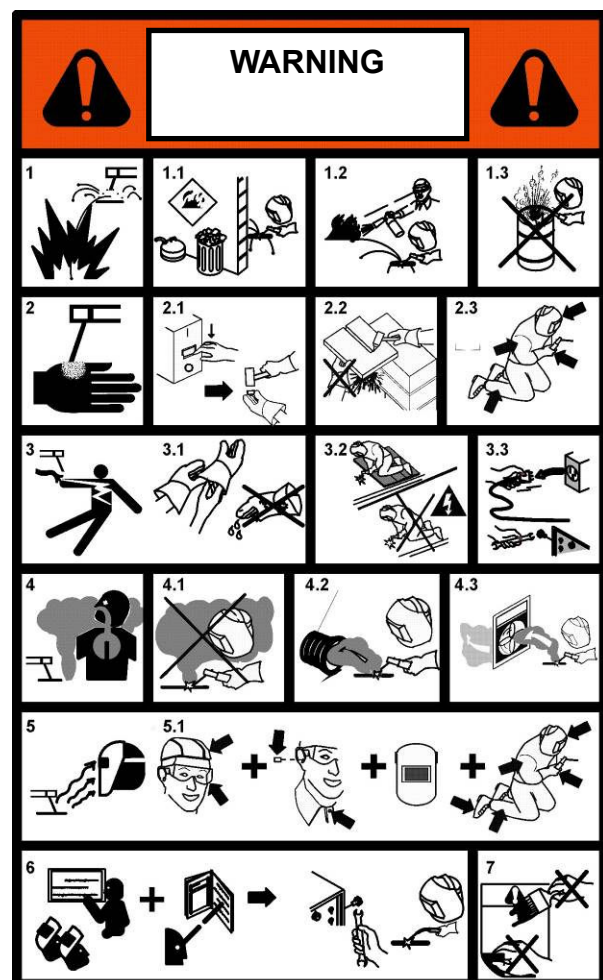

### PREVENTION OF BURNS

To protect your eyes and skin from burns and ultraviolet rays:

- wear dark glasses. Wear suitable clothing, gloves and footwear.
- use masks with closed sides, having lenses and

protective glass according to standards (degree of protection DIN 10).

- warn people in the vicinity not to look directly at the arc.

### PREVENTION OF FIRE

Welding produces splashes of molten metal.

Take the following precautions to prevent fire:

- ensure that there is a fire extinguisher in the welding area.

- remove all inflammable material from the immediate vicinity of the welding area.

- cool the welded material or let it cool before touching it or putting it in contact with combustible material

- never use the machine for welding containers of potentially inflammable material. These containers must be completely cleaned before they are welded.

- ventilate the potentially inflammable area before using the machine.

- do not use the machine in atmospheres containing high concentrations of powders, inflammable gases or combustible vapours.

## GENERAL CHARACTERISTICS

This new series of welding machines with electronic regulation controlled by a microprocessor, allows you to achieve excellent welding quality, thanks to the advanced technologies applied. The microprocessor circuit controls and optimises the transfer of the arc irrespective of the load variation and of the impedance of the welding cables.

The controls on the front panel allow easy programming of the welding sequences depending on the operating requirements.

The inverter technology used has allowed the following to be obtained:

- machines with extremely low weight and compact dimensions;

- reduced energy consumption;

- excellent dynamic response;

- very high power factor and yields;

- better welding characteristics;

- viewing of the data and of the set functions on the display.

The electronic components are enclosed in a sturdy structure that is easy to carry and cooled with forced air by fans with low noise production.

N.B. This welding machine is not suitable for thawing pipes.

## DELIVERY OF THE MATERIAL

The package contains:

- N. 1 welding machine

- N. 1 safety manual









Check that all the material listed above is included in the package. Inform your distributor if anything is missing. Check that all the material listed above is included in the package. Inform your distributor if anything is missing. Check that the machine has not been damaged in transport. If you see any sign of damage, consult the COMPLAINTS section for instructions. Before working with the machine, read the SAFETY and USE section of this manual.







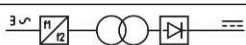

## COMPLAINTS

**Complaints for damage during transport:** If your equipment is damaged during transit you must present a claim to the carrier.

**Complaints for faulty goods:** All the equipment shipped by STEL is subjected to strict quality control. However, if your equipment does not work properly, consult your authorised dealer.

## TECHNICAL DATA

		Via Del Progresso, 59 36020 Castegnero (VI) – ITALY					
		TYPE: MAX 453 p/n 601506000L		EN 60974-1 EN 60974-10			
							
A		4 A / 20,16 V		450 A / 38 V			
		U <sub>0</sub>	V	I <sub>2</sub>	35%	60%	100%
B		70	U <sub>2</sub>	38 V	37,2 V	34 V	
		4 A / 10,16 V		450 A / 28 V			
C		U <sub>0</sub>	V	I <sub>2</sub>	35%	60%	100%
		70	U <sub>2</sub>	28 V	27,2 V	28 V	
D		15 A / 14,75 V		450 A / 36,5 V			
		U <sub>0</sub>	V	I <sub>2</sub>	35%	60%	100%
D		70	U <sub>2</sub>	36,5 V	35,5 V	31,5 V	
			U <sub>1</sub>	V	I <sub>MAX</sub>	A	I <sub>EFF</sub>
		3 ~ 50/60Hz	400	33,5	24,5		
		IP 23			Made in Italy		

A	 Via Del Progresso, 59 36020 Castegnero (VI) – ITALY		
	<b>TYPE: MAX 603 p/n 601475000L</b>	<b>EN 60974-1</b> <b>EN 60974-10</b>	
B			
		<b>4 A / 20,16 V</b>	<b>550 A / 42 V</b>
		<b>U<sub>0</sub></b> V <b>I<sub>2</sub></b> <b>35%</b> <b>60%</b> <b>100%</b>	<b>550 A</b> <b>500 A</b> <b>400 A</b>
		<b>70</b> <b>U<sub>2</sub></b> <b>42 V</b> <b>40 V</b> <b>36 V</b>	
C		<b>4 A / 10,16 V</b>	<b>550 A / 32 V</b>
		<b>U<sub>0</sub></b> V <b>I<sub>2</sub></b> <b>35%</b> <b>60%</b> <b>100%</b>	<b>550A</b> <b>500A</b> <b>400A</b>
		<b>70</b> <b>U<sub>2</sub></b> <b>32 V</b> <b>30 V</b> <b>26 V</b>	
		<b>15 A / 14,75 V</b>	<b>550 A / 41,5 V</b>
D		<b>U<sub>0</sub></b> V <b>I<sub>2</sub></b> <b>35%</b> <b>60%</b> <b>100%</b>	<b>550A</b> <b>500A</b> <b>400A</b>
		<b>70</b> <b>U<sub>2</sub></b> <b>41,5 V</b> <b>39 V</b> <b>35 V</b>	
		<b>U<sub>1</sub></b> <b>V</b> <b>I<sub>HMAX</sub></b> <b>A</b> <b>I<sub>HEFF</sub></b> <b>A</b>	
		<b>400</b> <b>50</b> <b>30</b>	
	<b>IP 23</b>	<b>Made in Italy</b>	

**A) IDENTIFICATION**

Name, address of the manufacturer  
 Type of welding machine  
 Identification with reference to serial number  
 Symbol of the type of welding machine  
 Reference to the construction standards

**B) WELDING OUTPUT**

Symbol of the work process  
 Symbol for welding machines suitable for working in an environment with a high risk of electric shock.  
 Symbol of the welding current  
 Assigned no-load voltage (operating voltage)  
 Range of the welding current  
 Values of the intermittence cycle (in 10 minutes)  
 Values of the assigned welding current  
 Values of the conventional loaded voltage

**C) POWER SUPPLY**

Power supply symbol (number of phases and frequency)  
 Assigned power supply voltage  
 Maximum power supply current  
 Maximum effective power supply current (identifies the line fuse)

**D) OTHER CHARACTERISTICS**

Degree of protection.

MAX 453/603		
Efficiency at 100% ED	MMA	87%
Idle state power consumption	MMA	65 W

**INSTALLATION****INSTALLATION**

**WARNING:** This **Class A** equipment is not intended for use in residential locations where the electrical power is provided by the public low-voltage supply system. There may be potential difficulties in ensuring electromagnetic compatibility in those locations, due to conducted as well as radiated disturbances. This equipment does not comply with **IEC 61000-3-12**. If it is connected to a public low voltage system, it is the responsibility of the installer or user of the equipment to ensure, by consultation with the distribution network operator if necessary, that the equipment may be connected. The good operation of the machine is ensured by correct installation; you must therefore proceed as follows:

- Position the machine in such a way that there is no obstacle to the air circulation ensured by the internal fan since the internal components require suitable cooling.
- Ensure that the fan does not send deposits or dust into the machine.
- Avoid impacts, rubbing, and – absolutely no exposure to dripping water, excessive heat sources, or any abnormal situations.

**MAINS VOLTAGE**

The machine operates from the following mains supply voltage(s):

MAX 453/603                      400V±15% 3P

With a Fuse rating of:

MAX 453                              25A 3P

MAX 603                              32A 3P

**CONNECTION**

- Before making the electrical connections between the welding machine and the line switch, ensure that the switch is turned off.
- The distribution panel must comply with the regulations in force in the country of use.
- The mains system must be of the industrial type.
- For longer connecting cables, increase the lead section as required.
- When using long extension cables, the cable core diameter size is relevant to the machine requirements for achieving optimum performance.
- The power input supply socket from the mains voltage supply, must have a suitable switch provided together with a 'slow-burning' type fuse(s).
- In the event of damage to the power cable, replacement or repair must be performed by a qualified person at an approved service centre.

### 3-PHASE CONNECTION

To connect the machine to a standard 3 phase power source see the following scheme:

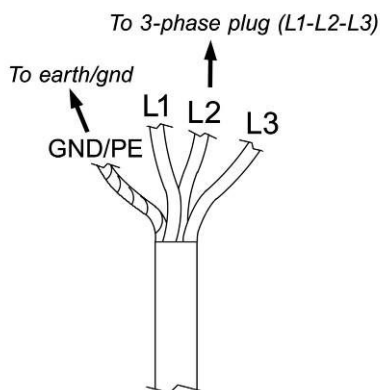

### EARTHING

- To ensure user protection the welding machine must absolutely be correctly connected to the earth system (INTERNATIONAL SAFETY REGULATIONS).

- It is indispensable to provide good earthing by means of the yellow-green lead in the power cable, in order to avoid discharges due to accidental contacts with earthed objects.

- The chassis (which is conductive) is electrically connected with the earth lead; if the equipment is not suitably connected to earth it may cause electric shocks which are dangerous for the user.

### LIFTING

#### WARNING:

The machine weights:  
MAX 453/603

50 Kg / 110 lb



#### Lifting by hand:

Lift the machine using the two handles provided.



#### Lifting with hoist and strap

Lift the machine by using **ONLY** both handles as shown on the picture.

Keep the machine as horizontal as possible

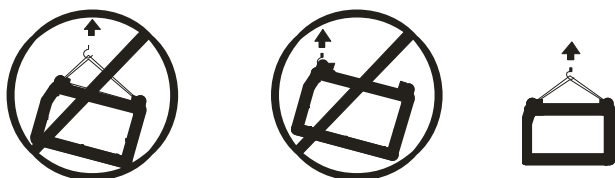

## INSTRUCTION FOR INSECURE POSITIONING

Failure to properly secure the machine can cause personal injury. If machine is in an insecure position do not attempt to switch on. Do not put the machine on an unlevelled surface greater than 10°.

## FRONT PANEL DESCRIPTION

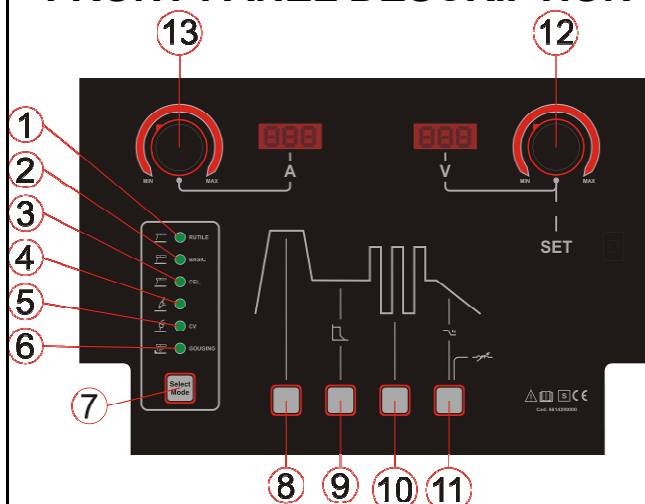

- 1 RUTILE ELECTRODE led indicating mode
- 2 BASIC ELECTRODE led indicating mode
- 3 CELLULOSIC ELECTRODE led indicating mode
- 4 TIG LIFT led indicating mode
- 5 MIG CV led indicating mode
- 6 AIR ARC GOUGING led indicating mode
- 7 **SELECT MODE** button
- 8 **Hot start** button
- 9 **Arc force** button
- 10 **Pulsed mode** button
- 11 **Slope Down/Inductance** button
- 12 Encoder for Voltage regulation/ other Functions **V/SET** ;
- 13 Encoder for Amps regulation **A**

## PREPARING FOR ELECTRODE WELDING

- 1) Respect the indications given previously concerning primary connection and installation.
- 2) Connect the earth cable to the socket of the machine. Negative polarity ( - )
- 3) Connect the electrode holder to the socket of the machine. Positive polarity ( + ) ;
- 4) Insert the bare core of the electrode in the gun;
- 5) Press the **Select Mode** (ref.7) button to select the ELECTRODE mode, indicated by the **LED** (ref.1,2,3,6);
- 6) Set the welding current with the encoder **A** (ref.13).
- 7) Proceed with welding.

**V.R.D. (ONLY IN MMA/TIG/GOUGING MODE)**

The initials V.R.D. stand for VOLTAGE REDUCTION DEVICE, which is a system for reducing the no-load voltage (OCV). When the V.R.D. is installed in a welding machine it reduces the maximum no-load voltage to a safety voltage which is normally less than 18V.

- The V.R.D. is used as an additional aid for operator safety.
- The procedures for safety at work must always be carried out with attention.

**ACTIVATION OF V.R.D.**

- 1) Switch on the welding machine;
- 2) Hold down button **Select Mode** (ref.7) for about 4 seconds, then release the button; the led indicating electrode mode start blinking (ref.1,2,3,6) (V.R.D. FUNCTION ON Vout 18V). VRD mode remains activated when switching the machine off and on again.

**DEACTIVATION OF V.R.D.**

- 1) Switch on the welding machine.;
- 2) Hold down button **Select Mode** (ref.7) for about 4 seconds, then release the button; the led indicating electrode mode remains lit with a fixed light (V.R.D. FUNCTION deactivated). VRD mode remains deactivated when switching the machine off and on again.

**PREPARING FOR TIG WELDING**

- 1) Respect the indications given previously concerning primary connection and installation.
- 2) Connect the earth cable to the socket of the machine. Positive polarity ( + )
- 3) Connect the torch coupling to the socket of the machine. Negative polarity ( - )
- 4) Connect the gas coupling of the torch to the gas connector in the front of the generator.
- 5) Connect the gas bottle to the connector provided on the rear of the generator.
- 6) With the **Select Mode** button (ref.7) to select the TIG LIFT mode (ref.4)
- 7) Set the welding current with the encoder **A** (ref.13).
- 8) Proceed with welding.

**PREPARING FOR MIG WELDING**

In this mode the generator behaves as a constant voltage generator, to weld in MIG mode it is necessary to connect it via a cable bundle to a compatible wire feeder. In case of connection with a wire feeder it is the power supply to take control of the welding parameters.

Compatible wire feeders:

- TOP 504 XXM
- TOP 504 SMX
- TOP 504 NAVY 5/15 ALU \* (Adapter kit cod.601632000L)
- SKY YARD 5/15 \* (Adapter kit cod.601631000L)

**PROTECTION FOR OVERCURRENT**

If the welding current is more than 580 Ampere there is a protection that automatically reduces welding parameters.

## PREPARING FOR GOUGING

Gouging applications normally use three-phase welding power supplies with an open circuit voltage higher than 60 volts, to allow for any voltage drop in the circuit.

1. Connect the Welding Power Cable that is connected to the Torch Swivel Cable to the positive terminal on the power supply. Refer to Figure.
2. Connect the Welding Power Cable that is connected to the negative terminal on the power supply to the workpiece.

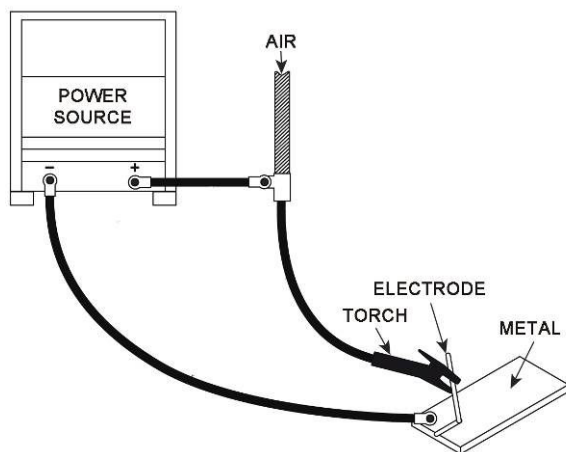

3. Turn on the power supply and air supply to the gouging torch and cable assembly.
4. While the torch valve is open, adjust the air pressure at the torch to the normal pressures range between 80 psi (552 kPa – 5,5 bar) and 100 psi (690 kPa – 6,9bar); higher pressures may be used, but they do not remove metal more efficiently.
5. Press down on the lever of the torch to insert the air carbon-arc electrode “carbon” into the torch. When using copper coated carbons, the bare carbon end should be down and away from the torch. This is where the arc will be struck between the carbon and workpiece. Refer to Figure.

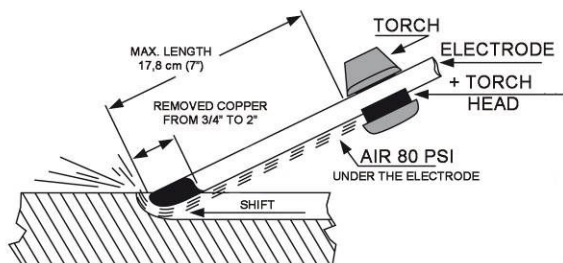

6. Hold the electrode as shown in Figure, so that a maximum of 7" (178 mm) extends from the torch. This extension should be 3" (76.5 mm) for aluminum.
7. Adjust the welding current, to the suggested current range shown for the carbon diameter

being used (see pag.28 –Gouging electrodes)

## SETTINGS

### HOT START REGULATION (TIG/ELECTRODE)

Press the button **Hot start** (ref.8) the display shows the current value of Hot start, it is possible adjust it with the encoder **V/SET** (ref.12).

H.S.= 0-30% RUTILE  
 = 0-50% BASIC  
 = 0-50% CEL.

### ARC FORCE REGULATION (ELECTRODE)

Press the button **Arc force** (ref.9) the display shows the current value of this parameter, it is possible adjust it with the encoder **V/SET** (ref.12).

A.F.= 0-30% RUTILE  
 = 0-50% BASIC  
 = 100-350% CEL.

### DC PULSE MODE REGULATION (ELECTRODE/TIG)

Press the button **DC PULSE** (ref. 10) for 3 seconds, activates the DC pulse signaled by flashing the two dots of the left display. By pressing the button (ref. 10) consecutively, you can adjust the pulse frequency (PFR) the duty cycle (PdU) and the base current (Ilo) with the V / SET encoder (ref.12). To deactivate the mode DC PULSE it is necessary to press the button (ref 10) for 3 seconds.

PFR = 0.4 - 5 Hz MMA / 0.4 - 999 Hz TIG  
 POU = 10-90%  
 ILo = 10-90%

### ELECTRONIC INDUCTANCE REGULATION (MIG CV)

Press the button **electronic inductance Car** (ref.11), the display shows the value of the selected inductance (25-200) on the display, and can be adjusted using the V / SET encoder (ref.12).

### SLOPE DOWN REGULATION (TIG)

Press the button **Slope down** (ref.11) the display shows the current value of this parameter (0,1-10sec) it is possible adjust it with the encoder **V/SET** (ref.12).

## DISPLAY MESSAGES

### COMUNICATION ERROR:



This message indicates a communication problem with accessories (example: Wire feeder). Check the connection of the 14-pole connector between the generator and accessories. Switch the generator off and on again.

### OVERTEMPERATURE:



This message indicates an overtemperature, the number indicates the position of the sensor that detected the overprinting:

-HT 1, HT 2, HT 3, HT 4 = NTC probe igbt module 1,2,4.

-HTd 5, HTd 7 = NTC probe secondary diodes.

-HTd 005, HTd 007 = thermostat XL out 1 and 2.

### PHASE FAILURE



This message indicates the lack of a phase of the supply voltage. Check the correct presence of the three phases at the generator inlet.

## DISPOSAL OF ELECTRICAL AND ELECTRONIC EQUIPMENT

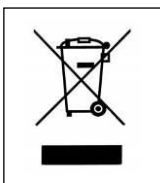

Do not dispose of electrical equipment together with normal waste! In observance of European Directive 2012/19/UE on Waste Electrical and Electronic Equipment and its implementation in accordance with national law, electrical equipment that has reached the end of its life must be collected separately and returned to an environmentally compatible recycling facility. As the owner of the equipment, you should get information on approved collection systems from our local representative. By applying this European Directive you will improve the environment and human health!

IN CASE OF MALFUNCTIONS, REQUEST ASSISTANCE FROM QUALIFIED PERSONNEL.

## DUTY CYCLE AND EXCESSES TEMPERATURE

The duty cycle is the percentage of use of the welding machine within 10 minutes which the operator must respect to avoid the machine blocking output due to temperature being exceeded.

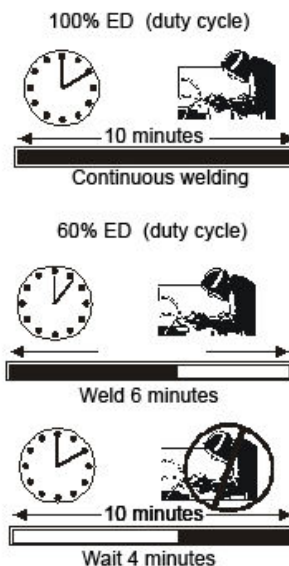

If the machine goes into overtemperature, the message HT will appear (see chapter overtemperature display messages).

After 4 minutes with the machine locked (necessary for cooling) the message will sweep and the generator is enabled again for welding.



## SICHERHEITSVORSCHRIFTEN EIN ELEKTROSCHOCK KANN TÖDLICH SEIN

- Vor Arbeiten am Gerät, Netzstecker ziehen
- Verwenden Sie keine beschädigten Kabel und Leitungen
- Berühren Sie keine unter Spannung stehenden elektrischen Bauteile
- Stellen Sie sicher, dass alle Abdeckungen fest geschlossen sind, bevor das Gerät an das Stromnetz angeschlossen wird.
- Sorgen Sie für einen ausreichenden Selbstschutz gegenüber dem Erd- bzw. Massepotential, durch die Verwendung von isolierendem Schuhwerk und Handschuhen.
- Halten Sie Handschuhe, Schuhwerk, Kleidung, ihren Arbeitsplatz, sowie das Gerät samt Ausrüstung, trocken und sauber.

## UNTER DRUCK STEHENDE BEHÄLTER KÖNNEN BEIM SCHWEISSEN EXPLODIEREN

Wenn Sie mit einem Schweißgerät arbeiten:

- Schweißen Sie keine unter Druck stehenden Behälter
- Schweißen Sie nicht in Umgebungen mit explosiven Stäuben oder Dämpfen

## DIE DURCH DEN LICHTBOGEN ERZEUGTE STRAHLUNG KANN IHR AUGENLICHT SCHÄDIGEN

- Sorgen Sie für ausreichende Schutzkleidung für Augen und Körper
- **Für Kontaktlinsenträger ist es absolut notwendig, sich mit geeigneten Linsen und Schutzmasken zu schützen.**

## LÄRM KANN IHR GEHÖR SCHÄDIGEN

- Schützen Sie sich durch ausreichenden Gehörschutz vor Gehörschäden

## DÄMPFE UND GASE KÖNNEN IHRE GESUNDHEIT SCHÄDIGEN

- Kopf von schädlichem Dämpfen und Gasen fernhalten
- Sorgen Sie für eine ausreichende Belüftung des Arbeitsbereichs
- Sollte die Belüftung nicht ausreichend sein, benutzen Sie ein geeignetes Absauggerät, welches von Unten absaugt.

## HITZE, FLÜSSIGE METALLSPRITZER UND FUNKEN KÖNNEN FEUER VERURSACHEN

- Schweißen Sie nicht in der Nähe von entflammaren Materialien
- Tragen Sie keine entflammaren Dinge mit sich, wie Feuerzeuge oder Streichhölzer
- Der Lichtbogen kann Brände verursachen. Halten Sie die Spitze der Elektrode von Ihrem Körper, sowie von Personen in Ihrer Nähe, fern.

## VORSICHTSMASSNAHMEN UM EINEN ELEKTROSCHOCK ZU VERHINDERN

Treffen Sie folgende Vorkehrungen, wenn Sie mit einem Schweißgerät arbeiten:

- Halten Sie sich und Ihre Kleidung sauber.
- Berühren Sie keine feuchten oder nassen Teile, wenn Sie mit dem Schweißgerät arbeiten.
- Halten Sie eine ausreichende Isolation gegen einen Elektroschock aufrecht. Sollte der Anwender in einer feuchten Umgebung arbeiten müssen, ist für größte Vorsicht zu sorgen und geeignetes, isolierendes Schuhwerk und Handschuhe zu tragen.
- Überprüfen Sie das Netzkabel regelmäßig: Es darf keine Beschädigungen an der Isolation aufweisen. **BLANKE KABEL SIND GEFÄHRLICH.** Benutzen Sie das Gerät nicht, wenn das Netzkabel beschädigt ist; es muss sofort ausgetauscht werden.
- Sollte es notwendig sein, das Gerät zu öffnen, ziehen Sie zuerst den Netzstecker. Warten Sie 5 Minuten, damit sich die Kondensatoren entladen können. Die Missachtung dieser Vorsichtsmaßnahme setzt den Anwender einem hohen Risiko aus, einen Elektroschock zu erleiden.
- Arbeiten Sie nie mit dem Schweißgerät, wenn die Schutzabdeckung geschlossen ist.
- Stellen Sie sicher, dass Erdung des Stromversorgungskabels ausreichend leistungsfähig ist. Dieses Gerät wurde für den Einsatz in Beruf und Industrie entwickelt. Für andere Arten der Anwendung kontaktieren Sie bitte den Hersteller. Werden **elektromagnetische Störungen** festgestellt, liegt es in der Verantwortung des Gerätebetreibers das Problem mit Hilfe des technischen Kundendienstes des Herstellers zu lösen. **Für Personen, die einen Herzschrittmacher tragen, ist es verboten das Gerät zu bedienen, bzw. sich im Bereich des Geräts aufzuhalten.**



## **VORSICHTSMASSNAHMEN UM VERBRENNUNGEN ZU VERHINDERN**

Maßnahmen, um Ihre Augen und Ihre Haut vor Verbrennungen und ultravioletter Strahlung zu schützen:

- Tragen Sie eine dunkle Schutzbrille. Tragen Sie angemessene Kleidung, Handschuhe und Schuhwerk.
- Benutzen Sie Kopfschutzhauben mit geschlossenen Seiten, sowie Linsen und Schutzgläser gemäß Standard (Schutzstufe DIN 10).
- Weisen Sie Personen, die sich in unmittelbarer Nähe aufhalten, darauf hin, nicht direkt in den Lichtbogen zu schauen.

## **VORSICHTSMASSNAHMEN UM BRÄNDE ZU VERHINDERN**

Schweißen verursacht flüssige Metallspritzer.

Treffen Sie folgende Vorkehrungen, um einen Brand zu vermeiden.

- Stellen Sie sicher, dass ein Feuerlöscher im Schweißbereich bereit steht.
- Entfernen Sie alle entflammaren Materialien aus der direkten Umgebung des Schweißbereichs.
- Kühlen Sie das geschweißte Material oder lassen Sie es abkühlen, bevor Sie es mit brennbaren Materialien in Kontakt bringen.
- Benutzen Sie nie das Gerät um Behälter zu schweißen, welche möglicherweise brennbares Material enthielten. Diese Behälter müssen vor dem Schweißen komplett gereinigt werden.
- Durchlüften Sie den feuergefährdeten Bereich, bevor Sie das Gerät benutzen.
- Verwenden Sie nicht das Gerät in Bereichen mit hoher Konzentration an Stäuben, entflammaren Gasen und brennbaren Dämpfen.

## **ALLGEMEINE EIGENSCHAFTEN**

Diese neue Reihe von Schweißgeräten ist mit einer elektronischen Stabilisierung ausgestattet, welche von einem Mikroprozessor gesteuert wird. Dank dem Einsatz dieser ausgereiften Technologie, ist es möglich, ein ausgezeichnetes Schweißergebnis zu erzielen. Die Mikroprozessorschaltung steuert und optimiert den Transfer des Lichtbogens, ungeachtet der Lastschwankung und des Schweißkabelwiderstands.

Die Steuerung an der Frontplatte ermöglicht ein einfaches Programmieren der Schweißfolge in Abhängigkeit der Arbeitsanforderungen.

Die eingesetzte Inverter Technologie ermöglicht folgende Punkte:

- Maschinen mit extrem geringem Gewicht und kompakten Abmessungen;
- geringerer Energieverbrauch;
- ausgezeichnetes, dynamisches Ansprechen;
- sehr hoher Leistungsfaktor und Wirkungsgrad;
- bessere Schweißeigenschaften;

- Anzeigen der Daten und eingestellten Funktionen im Display;

Die elektronischen Bauteile sind in eine solide Konstruktion eingefügt, leicht zu transportieren und werden geräuscharm durch den Lüfter gekühlt.

N.B. Das Schweißgerät ist nicht dazu geeignet, Rohre aufzutauen.

## **LIEFERUMFANG**

Das Paket enthält:

- Nr. 1 Schweißgerät
- Nr. 1 Sicherheitshandbuch











Überprüfen Sie, ob alle oben genannten Dinge im Paket enthalten sind. Sollte etwas fehlen, informieren Sie bitte Ihren Händler. Überprüfen Sie das Gerät auf etwaige Transportschäden. Sollten Sie Transportschäden feststellen, setzen Sie sich bitte mit der Abteilung für REKLAMATIONEN in Verbindung, um weiterführende Anweisungen zu erhalten. Bevor Sie das Gerät in Betrieb nehmen, lesen Sie bitte die SICHERHEITS- und GEBRAUCHSHINWEISE in dieser Betriebsanleitung.











## **REKLAMATION**

**Reklamation von Transportschäden:** Im Falle einer Beschädigung während des Transports müssen Sie Ihren Anspruch gegenüber dem Spediteur geltend machen.

**Reklamation fehlerhafter Ware:** Sämtliche Geräte, welche von STEL versendet werden, unterliegen einer strengen Qualitätskontrolle. Sollte jedoch Ihr Gerät nicht einwandfrei funktionieren, nehmen Sie bitte Kontakt zu Ihrem autorisierten Händler auf.

## ELEKTRISCHE MERKMALE

A	 Via Del Progresso, 59 36020 Castegnero (VI) – ITALY						
	TYPE: MAX 453 p/n 601506000L	EN 60974-1 EN 60974-10					
B							
		<b>4 A / 20,16 V</b>	<b>450 A / 38 V</b>				
		$U_0$ V $I_2$	35%    60%    100%				
	70 $U_2$	450 A    430 A    350 A					
B		<b>4 A / 10,16 V</b>	<b>450 A / 28 V</b>				
		$U_0$ V $I_2$	35%    60%    100%				
	70 $U_2$	450A    430A    350A					
		<b>15 A / 14,75 V</b>	<b>450 A / 36,5 V</b>				
B		$U_0$ V $I_2$	35%    60%    100%				
	70 $U_2$	450A    430A    350A					
		<b>15 A / 14,75 V</b>	<b>450 A / 36,5 V</b>				
		$U_0$ V $I_2$	35%    60%    100%				
C		$U_1$	$V$	$I_{MAX}$	$A$	$I_{EFF}$	$A$
	3 ~ 50/60Hz	400		33,5		24,5	
D	IP 23						Made in Italy

A	 Via Del Progresso, 59 36020 Castegnero (VI) – ITALY						
	TYPE: MAX 603 p/n 601475000L	EN 60974-1 EN 60974-10					
B							
		<b>4 A / 20,16 V</b>	<b>550 A / 42 V</b>				
		$U_0$ V $I_2$	35%    60%    100%				
	70 $U_2$	550 A    500 A    400 A					
B		<b>4 A / 10,16 V</b>	<b>550 A / 32 V</b>				
		$U_0$ V $I_2$	35%    60%    100%				
	70 $U_2$	550A    500A    400A					
		<b>15 A / 14,75 V</b>	<b>550 A / 41,5 V</b>				
B		$U_0$ V $I_2$	35%    60%    100%				
	70 $U_2$	550A    500A    400A					
		<b>15 A / 14,75 V</b>	<b>550 A / 41,5 V</b>				
		$U_0$ V $I_2$	35%    60%    100%				
C		$U_1$	$V$	$I_{MAX}$	$A$	$I_{EFF}$	$A$
	3 ~ 50/60Hz	400		50		30	
D	IP 23						Made in Italy

### a) IDENTIFIKATION

Name, Adresse des Herstellers

Schweißgerätetyp

Identifikation mit Verweis auf die Seriennummer

Symbol des Typs des Schweißgeräts

Verweis auf Bau Norm

### b) SCHWEISSLEISTUNG

Symbol für den Arbeitsprozess

Symbol für Schweißgeräte, die für den Einsatz in Umgebungen mit hohem Elektroschockrisiko, geeignet sind.

Symbol für den Schweißstrombereich

Zugeteilte Leerlaufspannung (Betriebsspannung)

Schweißstrombereich

Wert des Unterbrechungszykluses (in 10 Minuten)

Wert des zugeteilten Schweißstrombereichs

Wert der genormten Lastspannung

### c) STROMZUFÜHRUNG

Symbol der Stromzuführung (Anzahl der Phasen und Frequenz)

Zugewiesene Netzspannung

Bemessungswert der maximalen Netzspannung

Bemessungswert der effektiven Netzspannung

(gibt die Netzabsicherung an)

### d) WEITERE EIGENSCHAFTEN

Schutzart.

MAX 453/603		
Wirkungsgrad	MMA	87%
Leerlaufleistung	MMA	65 W

## MONTAGE

### INSTALLATION

Dieses **Klasse A** Gerät ist nicht zum Betrieb in häuslicher Umgebung vorgesehen, in der der Strom vom öffentlichen Niederspannungsnetz zur Verfügung gestellt wird. Dort können mögliche Schwierigkeiten auftreten, die elektromagnetische Verträglichkeit auf Grund von leistungsgeführten und gestrahlten Störgrößen zu gewährleisten. ie MAX-403, Schweißgerät **ist nicht** im Einklang mit **IEC 61000-3-12**. Wenn es zu einer Gemeinschaft Niedervolt-System verbunden, ist es die Verantwortung des Benutzers oder der Installateur, dass vielleicht ist es ratsam mit der Strom-Netz-Gemeinde vor dem Anschluss der Schweißgerät zu konsultieren.

### NETZSPANNUNG

Die Schweißgeräte funktioniert von der folgenden

Netzspannung:

MAX 403

400V 3-Phasen +/- 15 %

mit einer Netz Absicherung von

MAX 453

25 A Fuse

MAX 603

32 A Fuse

### ANSCHLUSS

- Bevor Sie den elektrischen Anschluss zwischen dem Schweißgerät und dem Leitungsschalter herstellen, stellen Sie sicher, dass der Schalter auf Aus steht.

- Die Verteilertafel muss mit den Vorschriften im Bestimmungsland des Gerätegebrauchs übereinstimmen.
- Die Netzversorgung muss für die industriellen Anforderungen geeignet sein.
- Bei der Verwendung von langen Verlängerungskabel, ist das Kabel Kerndurchmesser Größe relevant zu den Schweiß-Maschine für eine optimale Leistung- Die Leistungsaufnahme Steckdose von der Netzspannung, muss ein Schalter mit 'langsam brennende' Sicherung (en) zur Verfügung gestellt.
- Im Falle einer Beschädigung der Netzkabel, Ersatz oder Reparatur kann nur von einer qualifizierten Person in einer zugelassenen Service-Center vorgenommen werden.

### ERDUNG

- Um den Anwenderschutz sicher zu stellen, muss das Gerät korrekt an die Erdungsanlage angeschlossen werden.  
(INTERNATIONALE SICHERHEITSVORSCHRIFTEN)
- Um Entladungen bei versehentlichem Kontakt mit geerdeten Objekten zu vermeiden, ist es unentbehrlich für eine gute Erdung, unter Verwendung der grün-gelben Leitung im Netzkabel zu sorgen.
- Das Gehäuse (welches leitfähig ist), ist elektrisch mit der Erdungsleitung verbunden; ist das Gerät nicht entsprechend geerdet, kann dies zu einem, für den Anwender sehr gefährlichen, Elektroschock führen.

### 3-PHASENANSCHLUSS

Um das Gerät an eine standardmäßige 3-Phasen-Stromquelle anzuschließen, beachten Sie das folgende Schema:

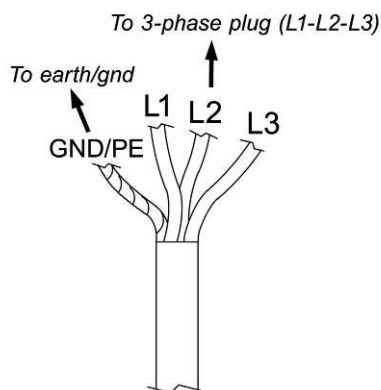

## ANHEBEN DES GERÄTS

### WARNUNG:

Das Gerät wiegt **MAX 453/603 50kg / 110lb.**



### Anheben von Hand:

Heben Sie das Gerät an, indem Sie beide Griffe benutzen.

### Anheben mit dem Flaschenzug und Gurten:

Das Gerät NUR anheben, indem Sie beide Griffe benutzen, wie im Bild dargestellt. Halten sie das Gerät so waagrecht wie möglich.

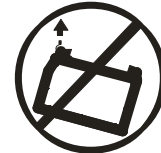
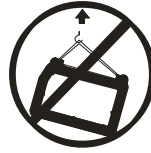

## WARNHINWEISE BEI UNSICHERER POSITIONIERUNG

Die nicht fachgerechte Sicherung des Geräts kann Personen verletzen.

Wenn das Gerät unsicher aufgestellt ist, schalten Sie das Gerät nicht ein. Stellen Sie das Gerät nicht auf Untergründe mit mehr als 10° Neigungswinkel.

## FRONT PANEL DESCRIPTION

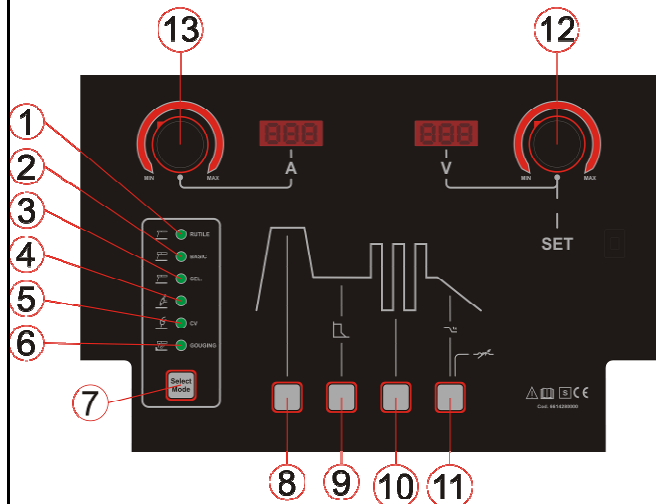

- 1 RUTILE ELECTRODE LED zeigt den Modus an
- 2 LED BASIC ELECTRODE zeigt den Modus an
- 3 CELLULOSIC ELECTRODE LED zeigt den Modus an
- 4 WIG LIFT LED zeigt den Modus an
- 5 MIG CV LED-zeigt den Modus an
- 6 AIR ARC GOUGING LED zeigt den Modus an
- 7 **SELECT MODE**-Taste
- 8 **Hot Start**-Taste
- 9 **Arc Force**-Taste
- 10 **Puls Mode** Taste
- 11 **Slope Down / Inductance** -Taste
- 12 Encoder für Spannungsregelung / Sonstige Funktionen **V / SET**;
- 13 Encoder für Ampereregulung **A**

## VORBEREITUNG FÜR DAS ELEKTRODENSCHWEISSEN

- 1) Beachten Sie die zuvor angegebenen Hinweise zum primären Anschluss und zur Installation.
- 2) Verbinden Sie das Erdungskabel mit der Buchse der Maschine. Negative Polarität (-)
- 3) Schließen Sie den Elektrodenhalter an die Buchse der Maschine an. Positive Polarität (+);
- 4) Führen Sie den blanken Kern der Elektrode in die Pistole ein.
- 5) Drücken Sie die Taste **Select Mode** (Bez. 7), um den ELEKTRODE-Modus auszuwählen, der durch die **LED** (Bez. 1, 2, 3, 6) angezeigt wird.
- 6) Stellen Sie den Schweißstrom mit dem Encoder ein **A** (Ref. 13).
- 7) Mit dem Schweißen fortfahren.

### V.R.D. (NUR IM MMA/TIG/GOUGING-MODUS)

Die Initialen V.R.D. steht für VOLTAGE REDUCTION DEVICE, ein System zur Reduzierung der Leerlaufspannung (OCV). Wenn der V.R.D in ein Schweißgerät eingebaut wird, reduziert er die maximale Leerlaufspannung auf eine Sicherheitsspannung, die normalerweise unter 18 V liegt.

- Die V.R.D. wird als zusätzliche Hilfe für die Bediener-sicherheit verwendet.
- Die Verfahren zur Arbeitssicherheit müssen immer mit Sorgfalt ausgeführt werden.

### AKTIVIERUNG VON V.R.D.

- 1) Schweißgerät einschalten;
- 2) Halten Sie die Taste Select Mode (Ref. 7) etwa 4 Sekunden lang gedrückt und lassen Sie die Taste dann los. Der LED-Anzeige-Elektrodenmodus beginnt zu blinken (Nr. 1, 2, 3, 6) (V.R.D.-FUNKTION AUF Vout.18 V). Der VRD-Modus bleibt aktiviert, wenn Sie die Maschine aus- und wieder einschalten.

### DEAKTIVIERUNG VON V.R.D.

- 1) Das Schweißgerät einschalten .
- 2) Halten Sie die Taste **Select Mode** (Ref. 7) etwa 4 Sekunden lang gedrückt und lassen Sie die Taste dann los. Der LED-Anzeige-Elektrodenmodus leuchtet weiterhin mit einem festen Licht (V.R.D.-FUNKTION deaktiviert). Der V.R.D-Modus bleibt deaktiviert, wenn Sie die Maschine aus- und wieder einschalten.

## VORBEREITUNG FÜR DAS TIG-SCHWEISSEN

- 1) Beachten Sie die zuvor angegebenen Hinweise zum primären Anschluss und zur Installation.
- 2) Verbinden Sie das Erdungskabel mit der Buchse der Maschine. Positive Polarität (+)
- 3) Schließen Sie die Brennerkupplung an die

Buchse der Maschine an. Negative Polarität (-)  
4) Verbinden Sie die Gaskupplung des Brenners mit dem Gasanschluss an der Vorderseite des Generators.

- 5) Schließen Sie die Gasflasche an den Anschluss an der Rückseite des Generators an.
- 6) Wählen Sie mit der **Select-Mode**-Taste (Ref. 7) den TIG-LIFT-Modus (Ref. 4).
- 7) Stellen Sie den Schweißstrom mit dem Encoder ein **A** (Ref. 13).
- 8) Mit dem Schweißen fortfahren.

## VORBEREITUNG FÜR DAS MIG-SCHWEISSEN



In diesem Modus verhält sich der Generator wie ein Konstantspannungsgenerator. Um im MIG-Modus zu schweißen, muss er über ein Kabelbündel mit einem kompatiblen Drahtvorschubgerät verbunden werden. Beim Anschluss an einen Drahtvorschub übernimmt die Stromversorgung die Kontrolle der Schweißparameter.

Kompatible Drahtvorschubgeräte:

- TOP 504 XXM
- TOP 504 SMX
- TOP 504 NAVY 5/15 ALU \* (ADAPTER KIT COD.601632000L)
- SKY YARD 5/15 \* (ADAPTER KIT COD.601631000L)

## VORBEREITUNG FÜR DAS FUGENHOBELN ( GOUGING)

Fugenhobeln verwendet normalerweise dreiphasige Schweißstromversorgungen mit einer Leerlaufspannung von mehr als 60 Volt, um einen Spannungsabfall im Stromkreis zu ermöglichen.

1. Verbinden Sie das Schweißstromkabel, das mit dem Brenner-Schwenkkabel verbunden ist, mit dem positiven Anschluss der Stromversorgung (DCEP oder AC). Siehe Abbildung.
2. Verbinden Sie das Schweißstromkabel, das mit

dem Minuspol der Stromversorgung verbunden ist, mit dem Werkstück.

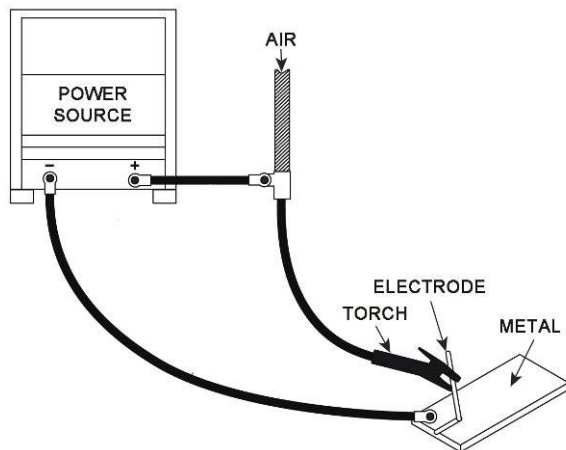

1. Schalten Sie die Stromversorgung und die Luftzufuhr zum Gouging-Brenner und Kabel ein.
2. Stellen Sie bei geöffnetem Brennerventil den Luftdruck am Brenner auf den normalen Druckbereich zwischen 80 psi (551,6 kPa) und 100 psi (690 kPa) ein. Höhere Drücke können verwendet werden, aber sie entfernen Metall nicht effizienter.
3. Drücken Sie den Hebel des Brenners nach unten, um die „Air-Carbon-Arc-Elektrode“ in den Brenner einzuführen. Bei der Verwendung kupferbeschichteter Kohlenstoffe sollte das blanke Kohlenstoffende unten und vom Brenner weg sein. Hier wird der Lichtbogen zwischen Kohlenstoff und Werkstück geschlagen. Siehe Abbildung.

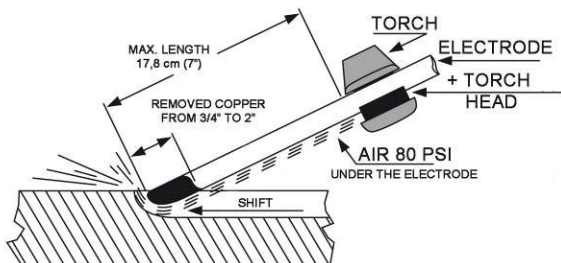

1. Halten Sie die Elektrode wie in der Abbildung gezeigt, so dass maximal 7 Zoll (178 mm) vom Brenner entfernt ist. Diese Verlängerung sollte für Aluminium 3 Zoll (76,5 mm) betragen.
2. Passen Sie den Schweißstrom (Konstantstrom) oder die Spannung (Konstantspannung) je nach Art der verwendeten Stromversorgung an den empfohlenen Strombereich an, der für den verwendeten Kohlenstoffdurchmesser angegeben ist.

## ÜBERSTROMSCHUTZ

Wenn der Schweißstrom mehr als 580 Ampere beträgt, gibt es einen Schutz, der die Schweißparameter automatisch reduziert.

## DIE EINSTELLUNGEN

### HOT – START-REGELUNG (WIG / ELEKTRODE)

Drücken Sie die Taste **HOT START** (Pos. 8). Auf dem Display wird der aktuelle Wert für den Warmstart angezeigt. Sie können diesen Wert mit dem Encoder **V / SET** (Pos. 12) einstellen.

H. S. = 0-30% RUTILE  
 = 0-50% BASIC  
 = 0-50% CEL.

### ARC FORCE-EINSTELLUNG (ELEKTRODE)

Drücken Sie die Taste **Arc force** (ref.9). Auf dem Display wird der aktuelle Wert dieses Parameters angezeigt. Es ist möglich, ihn mit dem Encoder **V / SET** (ref.12) einzustellen.

A. F. = 0-30% RUTILE  
 = 0-50% BASIC  
 = 100-350% CEL.

### DC-PULS-MODUS-EINSTELLUNG (ELEKTRODE / WIG)

Drücken Sie die Taste **DC PULSE** (Ref. 10) 3 Sekunden lang, um den DC PULSE zu aktivieren, der durch Blinken der beiden Punkte des linken Displays angezeigt wird. Durch aufeinanderfolgendes Drücken der Taste (Ref. 10) können Sie die PULS-Frequenz (PFR), die Einschaltdauer (PdU) und den Basisstrom (Ilo) mit dem **V / SET**-Encoder (Ref. 12) einstellen. Um den Modus DC PULSE zu deaktivieren, müssen Sie die Taste (Ref. 10) 3 Sekunden lang drücken.

PFR = 0,4 - 5 Hz MMA / 0,4 - 999 Hz WIG  
 POE = 10-90%  
 ILo = 10-90%

### ELEKTRONISCHE INDUKTIONSREGELUNG (MIG CV)

Drücken Sie die Taste elektronische Induktivität **Car** (Bez. 11). Das Display zeigt den Wert der ausgewählten Induktivität (25-200) im Display an und kann mit dem **V / SET**-Encoder (Bez. 12) eingestellt werden.

### SLOPE DOWN-REGELUNG (WIG)

Drücken Sie die Taste **Slope Down** (Ref. 11). Auf dem Display wird der aktuelle Wert dieses Parameters angezeigt (0,1-10 Sekunden). Er kann mit dem Drehgeber **V / SET** (Ref. 12) eingestellt werden.

## DISPLAY - MELDUNGEN

### KOMMUNIKATIONSFEHLER:



This message indicates a communication problem with accessories (example: Wire feeder). Check the connection of the 14-pole connector between the generator and accessories. Switch the generator off and on again.

### ÜBERTEMPERATUR:



Diese Meldung zeigt eine Übertemperatur an, die Zahl gibt die Position des Sensors an, der die Übertemperatur erkannt hat:

- HT 1, HT 2, HT 3, HT 4 = NTC-Sonde igbt-Modul 1,2,4.
- HTd 5, HTd 7 = Sekundärdioden der NTC-Sonde.
- HTd 005, HTd 007 = Thermostat XL aus 1 und 2.

### PHASENFEHLER



Diese Meldung zeigt das Fehlen einer Phase der Versorgungsspannung an. Überprüfen Sie das korrekte Vorhandensein der drei Phasen am Generatoreinlass.

## DUTY CYCLE (Einschaltdauer) UND ÜBERTEMPERATUR

Die Einschaltdauer ist der Prozentsatz der Nutzung des Schweißgeräts innerhalb von 10 Minuten, den der Bediener beachten muss, um zu verhindern, dass die Maschine aufgrund von Temperaturüberschreitungen blockiert ist.

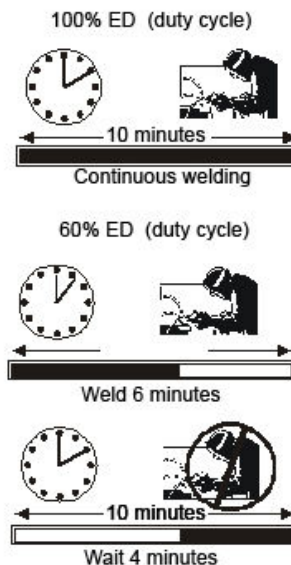

Wenn das Gerät überhitzt, erscheint die Meldung HT (siehe Kapitel DISPLAY – MELDUNGEN Übertemperatur).

Nach 4 Minuten, wenn die Maschine gesperrt ist (für die Kühlung erforderlich), die Meldung verschwindet und der Generator wird wieder zum Schweißen freigegeben.

## ENTSORGUNG VON ELEKTRISCHEN UND ELEKTRONISCHEN GERÄTEN



Entsorgen Sie keine elektrischen Geräte zusammen mit normalem Müll. Gemäß Europäischer Richtlinie 2012/19/UE über Elektro- und Elektronik- Altgeräte und Umsetzung in nationales Recht, müssen verbrauchte Elektro- und Elektronikgeräte getrennt gesammelt und einer umweltgerechten Wiederverwertung zugeführt werden. Als Eigentümer des Geräts sollten Sie bei Ihrem lokalen Händler, Informationen über ein lokales, autorisiertes Sammel- bzw. Entsorgungssystem einholen. Indem Sie diese Europäische Richtlinie befolgen, helfen Sie mit bei der Verbesserung der Umweltbedingungen und der Gesundheit der Menschen.

IM FALLE VON FEHLFUNKTIONEN, HOLEN SIE SICH HILFE VON QUALIFIZIERTEM PERSONAL

# WIRING DIAGRAM MAX 453

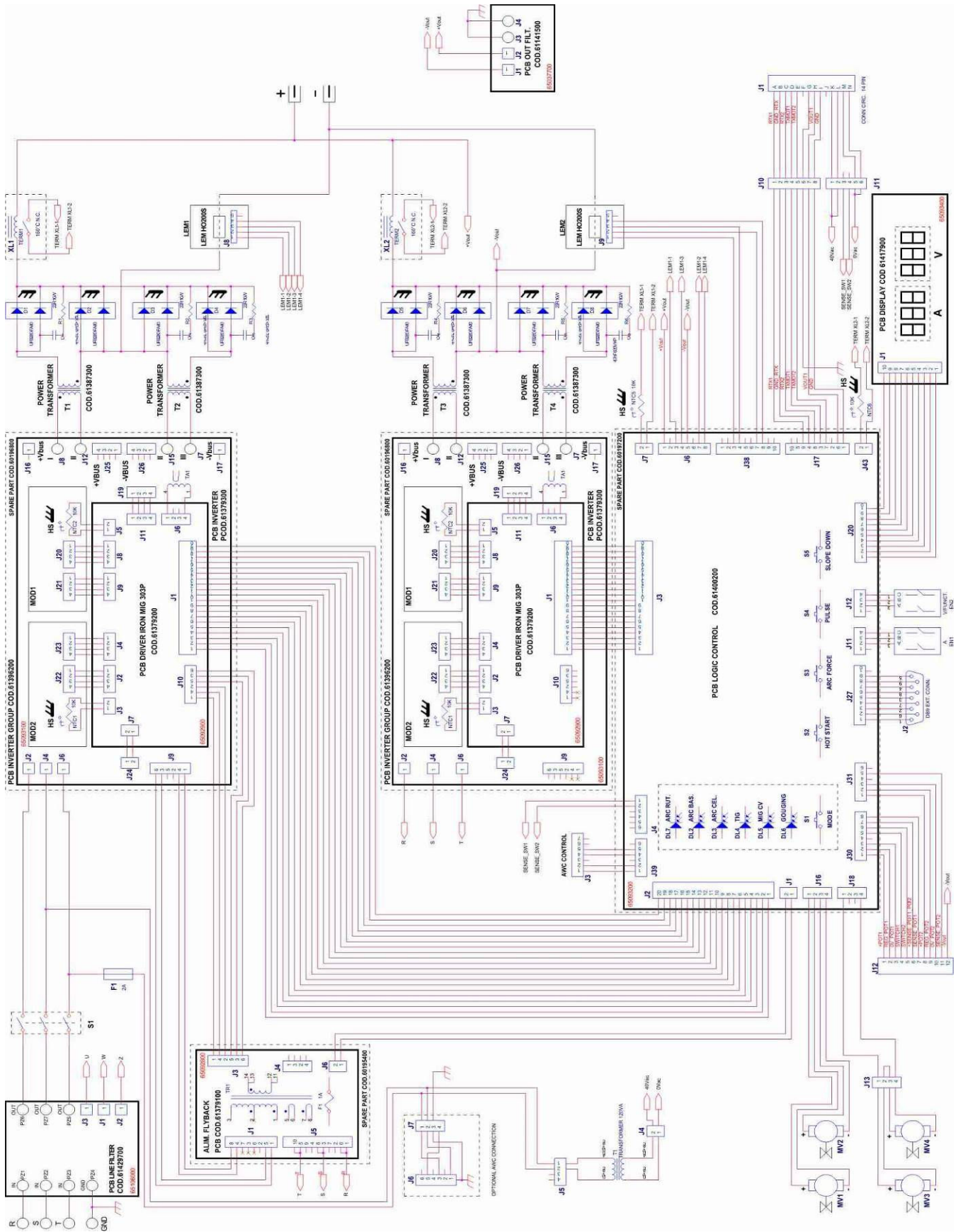



# WIRING DIAGRAM MAX 603

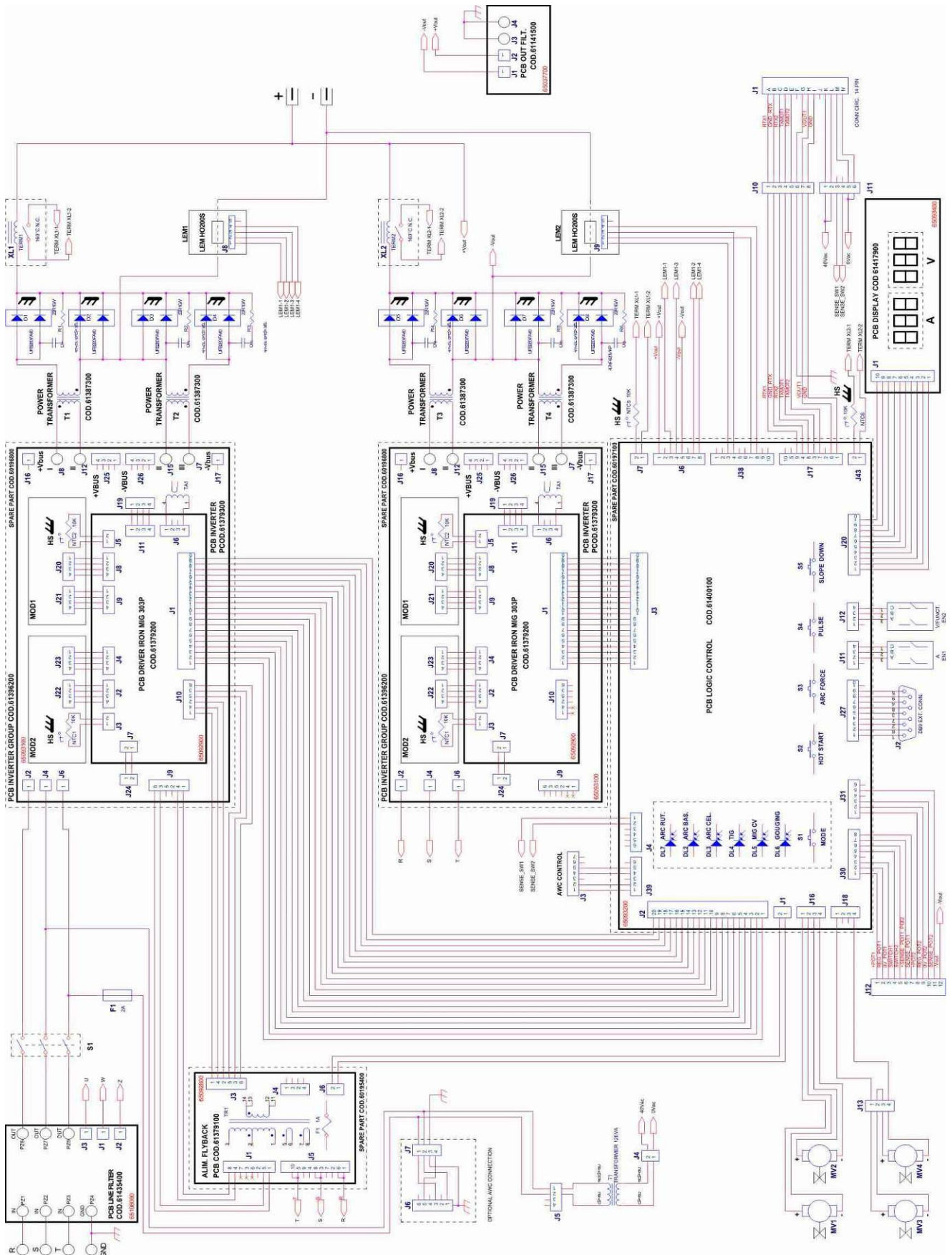

# EXPLODED VIEW

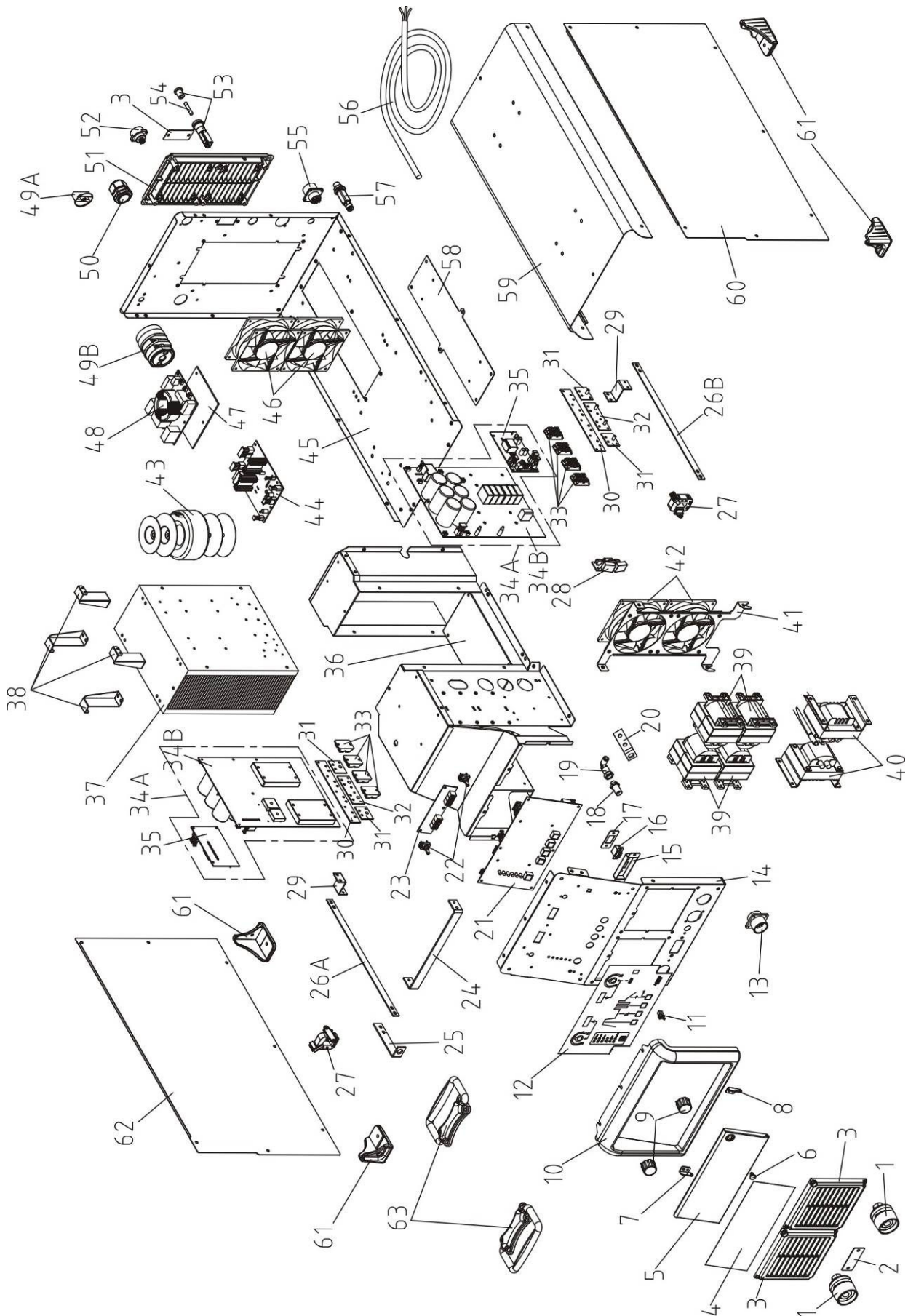

## SPARE PARTS

N°	DESCRIPTION	CODE	N°	DESCRIPTION	CODE
1	Welding socket	64550000	41	Interm. Fan support	6208830T
2	Conn. Cover 65x27	6205840K	42	Fan 92x92x38 12V	61316600
3	Front grid	6610430L	43	Auxiliary transformer	64781000
4	Front label	66143800	44	<b>PCB flyback</b>	<b>601954000L</b>
5	Front panel protection	620792UK	45	Base	6208140K
6	Door latch striker	66139300	46	Fan 120x120x38 24V	64814000
7	Left hinge	6207940K	47	Filter Insulation	66412000
8	Right hinge	6207930K	48	PCB line filter (for MAX 603)	61435400
9	Knob	66106200	48	PCB line filter (for MAX 453)	61429700
10	Front panel frame	6613850L	49	Power switch	64701000
11	Door latch	66139200	50	Cable relief	66078500
12	Front Instrument label	66142800	51	Rear grid	66109300
13	14 PIN connector	61409400	52	AWC control kit	61393100
13	*Optional 14 pin conn. For Navy	61XXXX00	53	Fuse holder	64776000
14	Front panel	6208120K	54	Fuse	64250000
15	Connector support	6205830T	55	<i>*Robot/auto kit (optional)</i>	-
16	Programming connector	65077500	55	Plastic Plug d.22-32.5	66037800
17	Connector support	6205490T	56	Power cable	64096000
18	Gas connector	63197000	57	Gas connector	63191+63197
19	Gas joint	63573000	58	Res. support	6208850K
20	Copper conn. POS	62088900	59	Top cover	620841CG
21	<b>PCB Front panel (for MAX 453)</b>	<b>601972000L</b>	60	Right cover	620838CG
21	<b>PCB Front panel (for MAX 603)</b>	<b>601971000L</b>	61	Plastic foot	6614180L
22	Encoder	61190200	62	Left cover	620839CG
23	PCB display 7 seg.	61417900	63	Handle	66103400
24	Copper conn. 20x3	62088700			
25	Copper conn. NEG	62088800			
26A	Copper conn. 15x2	62088600			
26B	Copper conn. 15x2	62080600			
27	LEM probe	65097700			
28	PCB output filter	611415V0			
29	Copper conn. 26x2	62080800			
30	Copper conn. Diodes 2	62050500			
31	Copper conn. Diodes 1	62050400			
32	Copper conn. 80x30x2	62080700			
33	Secondary power diode	65030200			
34	<b>PCB primary inverter group</b>	<b>601968000L</b>			
34A	PCB primary inverter	-			
35	PCB driver inverter	-			
36	Dissipator support	6208840T			
37	Dissipator	63668000			
38	Pcb inverter support	6208490T			
39	Power transformer	61407600			
40	Output inductor	61415500			

## CONNECTIONS

### FRONT TYPICAL CONNECTIONS:

REF	DESCRIPTION	MMA	TIG
A	NEGATIVE SOCKET	CLAMP	TIG TORCH
B	PROGRAMMING PORT	-	-
C	GAS OUT	-	TIG TORCH
D	CONNECTOR 14 WAY	-	-
E	POSITIVE SOCKET	ELECTRODE HOLDER	CLAMP

REF	DESCRIPTION	MIG (WITH OPTIONAL WIRE FEEDER)
A	NEGATIVE SOCKET	CLAMP
B	PROGRAMMING PORT	-
C	GAS OUT	TO WIRE FEEDER GAS INLET
D	CONNECTOR 14 WAY	TO WIRE FEEDER 14 WAY CONNECTOR
E	POSITIVE SOCKET	TO WIRE FEEDER POSITIVE CONNECTOR (MIG)

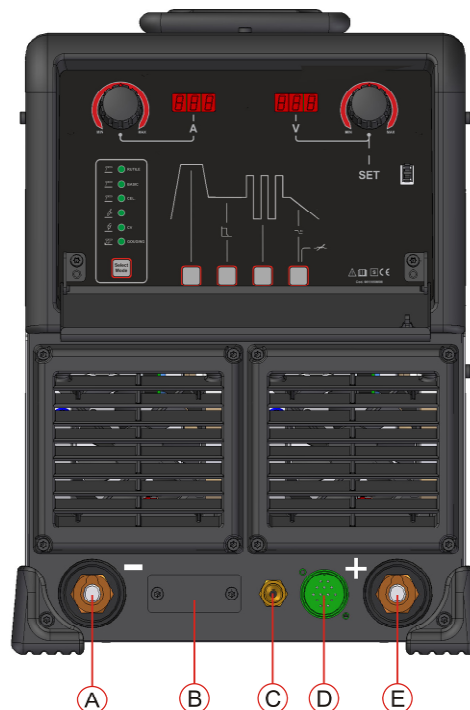

### REAR TYPICAL CONNECTIONS

REF	DESCRIPTION	MMA	TIG
F	AWC CONTROL	-	OPT. AWC
G	AWC SUPPLY (OPTIONAL)	-	OPT. AWC
H	AUSILIARY FUSE	T 2A 6,3x32 500V	T 2A 6,3x32 500V
I	GAS INPUT	-	TO GAS CYLINDER
J	MAIN SUPPLY INPUT	MAIN SUPPLY	MAIN SUPPLY

REF	DESCRIPTION	MIG MIG NO GAS
F	AWC CONTROL	OPT. AWC
G	AWC SUPPLY (OPTIONAL)	OPT. AWC
H	AUSILIARY FUSE	T 2A 6,3x32 500V
I	GAS INPUT	TO GAS CYLINDER
J	MAIN SUPPLY INPUT	MAIN SUPPLY

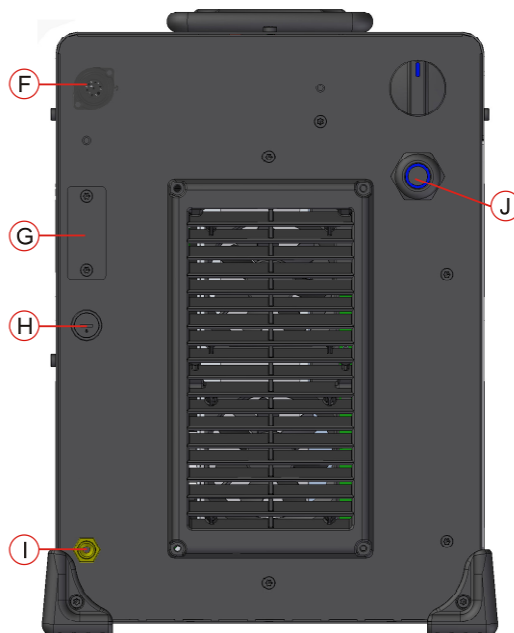

**REMOTE CONTROL 14 WAY CONNECTOR - STANDARD  
(FOR TOP 504 XXM – SMX)**

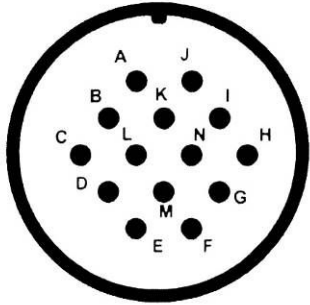
CONNECTOR 14 WAY 'D'	PIN	DESCRIPTION	
REMOTE CONTROL	K	+42Vac Output remote control	
	L	+42Vac Output remote control	
	M	0Vac Output remote control	
	N	0Vac Output remote control	
GND	G	Chassis common	
	A	Data Reception Serial Gate	
	B	Common Communication Serial Gate	
	C	Data Transmissions Serial Gate	
	D	Data Transmissions Serial Gate Speed Motor	
	E	Data Reception Serial Gate Speed Motor	
	H	Positive connection Welding Voltage	
	I	Negative connection Welding Voltage	

**AWC CONNECTION - STANDARD -**

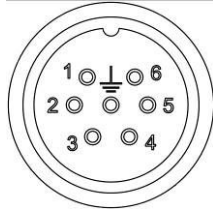
CONNECTOR 7 WAY 'F'	PIN	DESCRIPTION	
AWC CONTROL	1	COMMON	
	2	AWC CONTROL	
	3	NC	
	4	AWC PROTECTION	
	5	COMMON	
	6	NC	
	GND	NC	

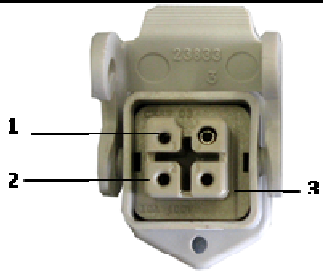
CONNECTOR ILME 4 WAY 'G'	PIN	DESCRIPTION	
AWC SUPPLY  (OPTIONAL KIT COD.600362000L)	1	POWER SUPPLY 230 V AC	
	2		
	1	POWER SUPPLY 400 V AC	
	3		
	4	EARTH LEAD	

**REMOTE CONTROL 14 WAY CONNECTOR (OPTIONAL KIT ADAPTER COD.601651000L)  
(FOR CAD RC1 – PEDAL)**

CONNECTOR 14 WAY 'D'	PIN	DESCRIPTION	
TORCH TRIGGER	A	Torch switch	
	B	Torch switch	
REMOTE CONTROL 1	E	Remote control circuit common	
	F	0 to +5V dc Input remote control 1	
	G	+5V Output remote control	
	D	+5V Output remote control	
REMOTE CONTROL 2	E	Remote control circuit common	
	F	0 to +5V dc Input remote control 1	
	G	+5V Output remote control	
SENSE 1	I	Sense 1 R 220K	
	J	Sense 1 R 220K	
SENSE 2	K	Sense 2 R 220K	
	L	Sense 2 R 220K	

**REMOTE CONTROL 14 WAY CONNECTOR "X ROTATION" (OPTIONAL KIT ADAPTER COD.601632000L)  
(FOR TOP 504 NAVY 5/15 ALU)**

CONNECTOR 14 WAY 'D'	PIN	DESCRIPTION	
REMOTE CONTROL	K	+42Vac Output remote control	
	L	+42Vac Output remote control	
	M	0Vac Output remote control	
	N	0Vac Output remote control	
GND	G	Chassis common	
	A	Data Reception Serial Gate	
	B	Common Communication Serial Gate	
	C	Data Transmissions Serial Gate	
	D	Data Transmissions Serial Gate Speed Motor	
	E	Data Reception Serial Gate Speed Motor	
	H	Positive connection Welding Voltage	
	I	Negative connection Welding Voltage	

**REMOTE CONTROL 14 WAY CONNECTOR (OPTIONAL KIT ADAPTER COD.601631000L)  
(FOR SKY YARD 5/15)**

CONNECTOR 14 WAY 'D'	PIN	DESCRIPTION	
	A	+42Vac Output remote control	
	B	0Vac Output remote control	
TORCH TRIGGER	C	Torch switch	
	D	Torch switch	
REMOTE CONTROL	E	+5V Output remote control	
	F	0 to +5V dc Input remote control	
	G	Remote control circuit common	
-VOUT REF.	H	-Vout Ref.	
MIG/MMA SWITCH	I	Switch 1	
	J	Switch 2	

## INFO

### - ARC FORCE (ONLY IN MMA MODE):

Avoids overheating of electrodes between a shot of current which prevents the electrode from sticking to piece that is being welded. The arc force is adjustable.

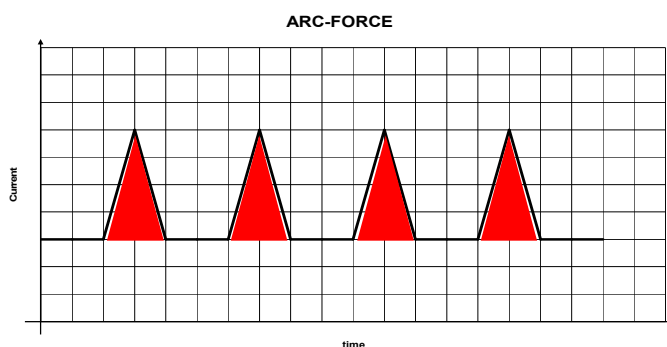

### - HOT START (ONLY IN MMA MODE):

The Hot-start supplies a extra current upon starting which allows the electrode to be immediately removed and promptly begin welding. The Hot-Start is adjustable.

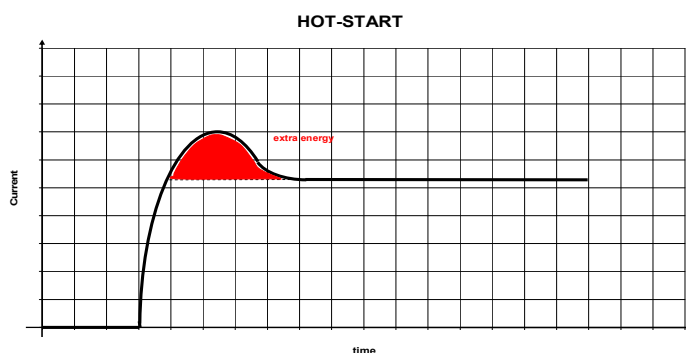

## IDEAL SETTING MMA MODE:

ELECTRODE	TYPE	DIAMETER	CURRENT	HOT START	ARC FORCE
RUTILE	6013	2,5	80	10	0
	6013	3,25	115	10	0
BASIC	7018	2,5	90	10	15
	7018	3,25	125	10	10
	7018	4	160	15	10
	7018	5	200	20	20
CELLULOSIC FLEETWELD 5P+ (Lincoln)	6010	2,5	50	20	250
	6010	3,25	70	20	250

## GOUGING ELECTRODES:

ELECTRODE SIZE (mm)	CURRENT (A)	METAL REMOVAL (g/cm)	WIDTH GROOVING (mm)	DEEP GROOVING (mm)	DEEP CUTTING (mm)	HOLE DIAMETER (mm)
4.0 x 305	150-200	10	6-8	3-4	7	8
5.0 x 305	150-200	12	7-9	3-5	8	8
6.3 x 305	200-250	18	9-11	4-6	9	10
8.0 x 305 *	250-350	33	11-13	6-9	11	12
9.5 x 305 **	350-450	49	13-15	8-12	13	14

Maximum electrode size to use generator at the 100% duty cycle :

(\*) for 453

(\*\*) for 603



**Info : [www.stelgroup.it](http://www.stelgroup.it) - tel. +39 0444 639525**